

2019

welcome to the backyard...



hardscapes **collection**



Welcome to Rochester Concrete Products 4-5
 Getting Started/Planning Guide 6-7
 KolorLast Pavers 8-9
 Ideas Gallery 10-23
Buy More, Get More Rebate 19

pavers

American Brick Paver 42-43
 Barrington Paver 34-35
 Broadmour Pavers 30-33
 Cobble Stone Paver 44-45
 Colonial Paver 50-51
 Flagstone Paver 48-49
 Holland/Holland-Eco Pavers 52-53
 Lamont Paver 46-47
 Mezzano Paver 40-41
 Minnetonka Paver 36-37
 Serano Paver 38-39

retaining walls

Barn Plank Garden Wall 55
 Classic 6 and 8 Walls 64-65
 Classic 8 Chiseled Face Wall 58-59
 Classic Colonial 6 and 8 Walls 64-65
 Compac Wall 67
 Cottage Stone Wall 71
 Lakeland and Riverland Walls 60-61
 Rosetta Walls (Kodah, Outcropping, Belvedere) 68-69
 Sapphire Wall 70
 Stonegate Wall 66
 Travertine Garden Wall 54
 Vintage 6 Wall 56-57

wet cast

Antique Travertine Landscape Tiles 26-27
 Barn Plank Landscape Tiles 24-25
 Chiseled Steps 72
 Coping 76
 Slate Landscape Tiles 28-29



outdoor living

NECESSARIES OUTDOOR LIVING KITS	82-83
- Colonial and Compact Fireplace Kit	86
- Contemporary Gas Fireplace Kit	85
- Dining/Pub Table, Compact Bar Kits	92-93
- Fire Rings and Fire Pit Kits	88-89
- Grand Fireplace Kit	84
- Grand Island Bar Series Kits	90-91
- Pillars and Seat Walls	105
- Victorian Fireplace Kit	87
- Waterfall Kits	104
- Wood-fired Outdoor Oven	92
NECESSARIES KITCHEN CABINET KITS	98-99
- Grill Kits	100
- Island and Refrigerator Kits	102-103
- Outdoor Oven, Woodbox Stand, Tool Kit	101
- Prep Center, Corner Kits	106
- Side Burner Kit	104
- Smoker, Trash Drawer Kits	105

accessories

Bullnose and Wet Cast Coping	76-77
Chiseled Caps and Tops	74-75
Edgers	80-81
Mini Cap	71
Rosetta Steps	68
Stepping Stones	78-79
Universal Caps	63, 69, 70
Steps (Big, Chiseled, Grand, Barn Plank, Travertine)	72-73
Wet Cast Fire Pit Kits	54-55

Please note: Our products are made from solid color concrete for lasting appearance and durability. Photographs contained herein are for representation only. Refer to actual product samples when making color selection. Product dimensions given are nominal. See 2019 Hardscapes Product Guide for pallet configurations, product specifications, patterns, detailed descriptions, warranties and color definitions.

The information presented here has been prepared for the benefit of customers interested in Rochester Concrete Products, it was reviewed carefully prior to publication. Rochester Concrete Products assumes no liability for its accuracy or completeness. Final determination of the suitability of any information or material for the use contemplated, or for its manner of use, is the sole responsibility of the user. Not all products available in all areas.



**welcome to
the backyard...**



...and welcome to Rochester Concrete Products. We are the preferred manufacturer and distributor of distinctive hardscape materials and supplies.

Since 1914, Rochester Concrete Products™ and its sister companies have been refining the art and science of interlocking concrete products. Rochester Concrete Products is recognized throughout North America for creating landscape products rich in texture, full of character and manufactured with the highest quality at an affordable price. For these reasons, Rochester Concrete Products is the professional's first choice.

There are many landscape materials in the marketplace to choose from, and only Rochester Concrete Products delivers the peace of mind you can trust.

Our products are rare because they combine beauty, durability and affordability. Rochester Concrete Products manufactures and distributes world leading brands: Necessories Outdoor Living Kits, Silver Creek Stoneworks, Rockwood Retaining Walls, Interlock Concrete Products, Rosetta Wall Systems, Keystone Retaining Wall Systems, Recon Retaining Walls and Alliance Gator polymeric sands, sealers and cleaners and many more landscape accessories and components.

Whether you're looking for an outdoor space complete with fireplace and dining table or a retaining wall to expand and support a backyard, this comprehensive catalog is a design gallery. There aren't enough pages to tell our entire story, so we invite you to visit www.rochesterpcp.com or scan the QR code to view more inspirational and award winning landscapes.



planning guide



The endless combinations of products available can make the selection process challenging. To simplify the task, follow these four design considerations when choosing materials for your backyard design.

1. Style – Style includes the shape, size and surface detail of a paver, slab, tile or wall. Choose a style that best suits the application and complements your surrounding architecture and expresses your personal flair.

2. Color – Whether you prefer a solid color, a blend or a combination of styles, shapes and colors, find one that complements or contrasts your roofing, siding or stonework. Also consider what furniture and decor, plantings and sealers will do to create the colors you'll always appreciate.

3. Pattern – Start by finding examples of landscapes and patterns you like, and share them with your landscape professional. An experienced pro can help you with your design process, budget, product selection, construction and maintenance.

4. Detail – Nothing completes a hardscape area like adding beautiful accents of inlays, caps/tops and borders. Use combinations of contrasting styles, color or patterning to create lasting flair for your outdoor living space.

Before planning your landscape project, check with your local zoning commission for building restrictions and required construction permits. Always call 811 before you dig.



Use this simple guide to help you and your landscape professional create an attractive and comfortable landscape you will enjoy everyday.

The real benefits of landscaping

Curb appeal – it's the best way to make a good first impression. Most homeowners agree, spending over \$45 billion on professional lawn and landscape services annually. Gardening has become America's #1 pastime, with over 80% of all households participating.

What does this mean to you?

A well designed landscape does more than bring increased value to your home, it brings energy savings as well. More importantly, quality landscaping brings you endless days of enjoyment.

So follow the number one trend in the country and bring the indoors out by adding a raised patio, fire pit or an outdoor kitchen. Regardless of what you do, the enjoyment of the outdoors will reduce your stress and add real value to your home.

Just follow these five simple planning steps:

- 1) Do your homework
- 2) Make a list
- 3) Make a budget
- 4) Sketch your design
- 5) Hire a qualified landscape contractor

1) Do your homework

Visit our website, Facebook or Instagram pages to see backyard patio plans, photos, ideas and MORE! The more ideas you have of hardscape materials, plants, accents and furniture – the better

2) Make a list

Make a list of things you like and dislike. If mowing the lawn or weeding a flower garden isn't for you, make note of it. Do you prefer rocks vs. mulch? Do you love flowers, but dread replanting every year? Highlight your interests below and share them with your landscape pro.

	Like	Dislike	Maybe
Modern	<input type="checkbox"/>	<input type="checkbox"/>	<input type="checkbox"/>
Natural	<input type="checkbox"/>	<input type="checkbox"/>	<input type="checkbox"/>
Relaxation / Quiet	<input type="checkbox"/>	<input type="checkbox"/>	<input type="checkbox"/>
Maintenance-free	<input type="checkbox"/>	<input type="checkbox"/>	<input type="checkbox"/>
Entertaining / Active	<input type="checkbox"/>	<input type="checkbox"/>	<input type="checkbox"/>
Matches Homes Architecture	<input type="checkbox"/>	<input type="checkbox"/>	<input type="checkbox"/>
Open and Spacious	<input type="checkbox"/>	<input type="checkbox"/>	<input type="checkbox"/>
Privacy and Shade	<input type="checkbox"/>	<input type="checkbox"/>	<input type="checkbox"/>
Eco-friendly / Energy Saving	<input type="checkbox"/>	<input type="checkbox"/>	<input type="checkbox"/>
Outdoor Kitchen	<input type="checkbox"/>	<input type="checkbox"/>	<input type="checkbox"/>
Outdoor Living Room	<input type="checkbox"/>	<input type="checkbox"/>	<input type="checkbox"/>
Accent Lighting	<input type="checkbox"/>	<input type="checkbox"/>	<input type="checkbox"/>
Fire Pit	<input type="checkbox"/>	<input type="checkbox"/>	<input type="checkbox"/>
Fireplace	<input type="checkbox"/>	<input type="checkbox"/>	<input type="checkbox"/>
Flower Garden	<input type="checkbox"/>	<input type="checkbox"/>	<input type="checkbox"/>
Water Feature / Pond	<input type="checkbox"/>	<input type="checkbox"/>	<input type="checkbox"/>
Paver Patio	<input type="checkbox"/>	<input type="checkbox"/>	<input type="checkbox"/>
Walkways	<input type="checkbox"/>	<input type="checkbox"/>	<input type="checkbox"/>
Sound System	<input type="checkbox"/>	<input type="checkbox"/>	<input type="checkbox"/>

3) Make a budget

When budgeting, plan to invest about 7-10% of your home's value. A more elaborate backyard sanctuary may require 15 to 20%. Much of what you will spend depends on how long you plan to stay in your home. If you plan to stay for more than ten years, 15 to 20% will give you the enjoyment you desire for years to come.

$$\text{Homes Value } \$ \text{ _____ } \times \text{ _____ } \% \\ = \text{ _____ } \text{ (Your landscaping budget)}$$

4) Sketch your design

Take out a pencil and paper and start at the beginning. Sketching will help you discover your likes and dislikes and make your landscaping process much easier.

5) Hire a qualified landscape contractor

If you're not quite the weekend warrior to tackle your own landscape construction, start talking to the professionals. Landscape pros are invaluable assets for their design expertise, product knowledge and construction methods.

When it's time to choose products, be sure you ask your landscaping professional

There are countless pavers, slabs and landscape tiles to choose from, the same goes for retaining wall blocks. Knowing what products are best suited for a particular landscape application is crucial. For example, pavers designed for heavy vehicle traffic are not good choices for small patios or walkways. And with retaining walls, a heavy-duty wall system probably isn't the right product for use as a small garden wall.

There's no better way to select material than to see and touch the real thing

Visit a Rochester Concrete Products distributor/dealer to touch and see actual samples in the colors you like. If you can't visit a dealer showroom where outdoor living products are displayed, ask your landscape contractor to get samples gathered for your consideration. Always refer to actual product samples when making color selection.



Our products have to live up to the damaging effects of time, Mother Nature and decades of use and abuse.

KolorLast is serious protection

Concrete treated with KolorLast is highly resistant to the harmful effects of salt, chemical and acid rain exposure. Another KolorLast benefit is it's much easier to remove liquid/food spills and rust marks—minimizing or preventing stains altogether.

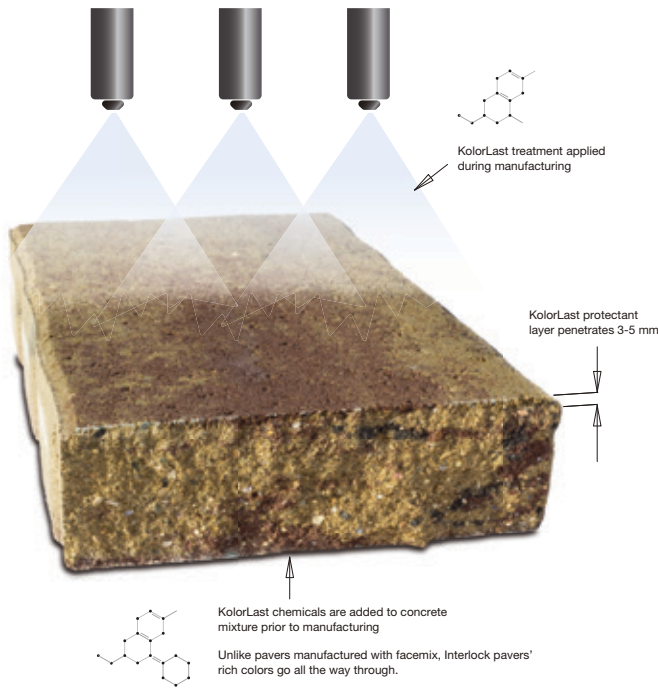

What is KolorLast?

The KolorLast manufacturing process is a simple chemical reaction between two compounds. First, a special mixture of cement, aggregates, water and a proprietary chemical additive are mixed into dry-mix concrete that is pressed into molds with extreme heat and pressure. Second, as pavers are demolded, a proprietary water-based solution is sprayed on the surface where a chemical/molecular reaction creates the KolorLast protective layer. This new protective compound penetrates into the surface of the paver – three to five millimeters deep. It can only be removed with heavy abrasion/wear.

KolorLast Protected pavers:

- Resist color fading indefinitely
- Resist effects of salt and acid rain
- Makes removing stains easier

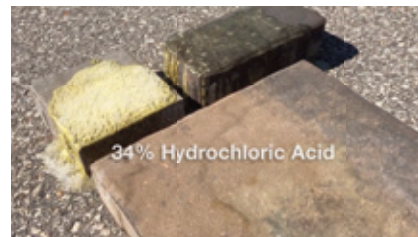
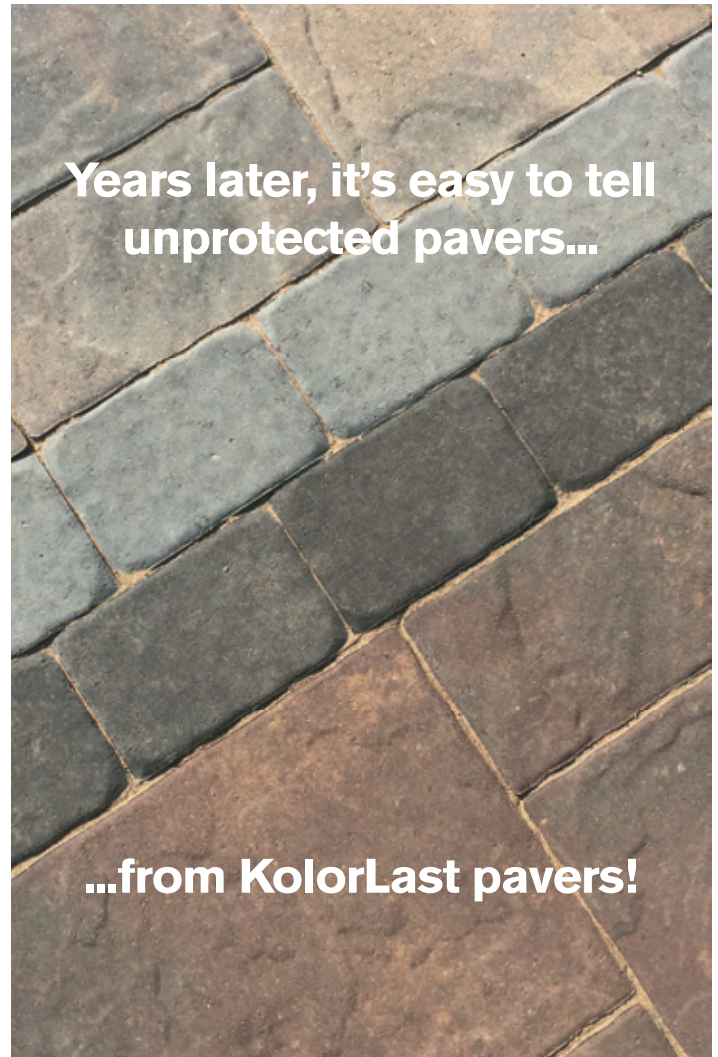

Watch the acid test video

34% hydrochloric acid is poured on an untreated paver, and two KolorLast treated pavers—one six months old, the other four years old. After 30 seconds, the acid had little effect on the KolorLast treated pavers, while the untreated sample is visibly damaged.

www.rochesterpc.com/KolorLast

KolorLast protected pavers are available only at Rochester Concrete Products.





KolorLast™
Hardscape Protectant



welcome to the backyard...
...you're going to love it out here!







Complete warranty at: www.rochesterop.com





driveways







patios & pool decks

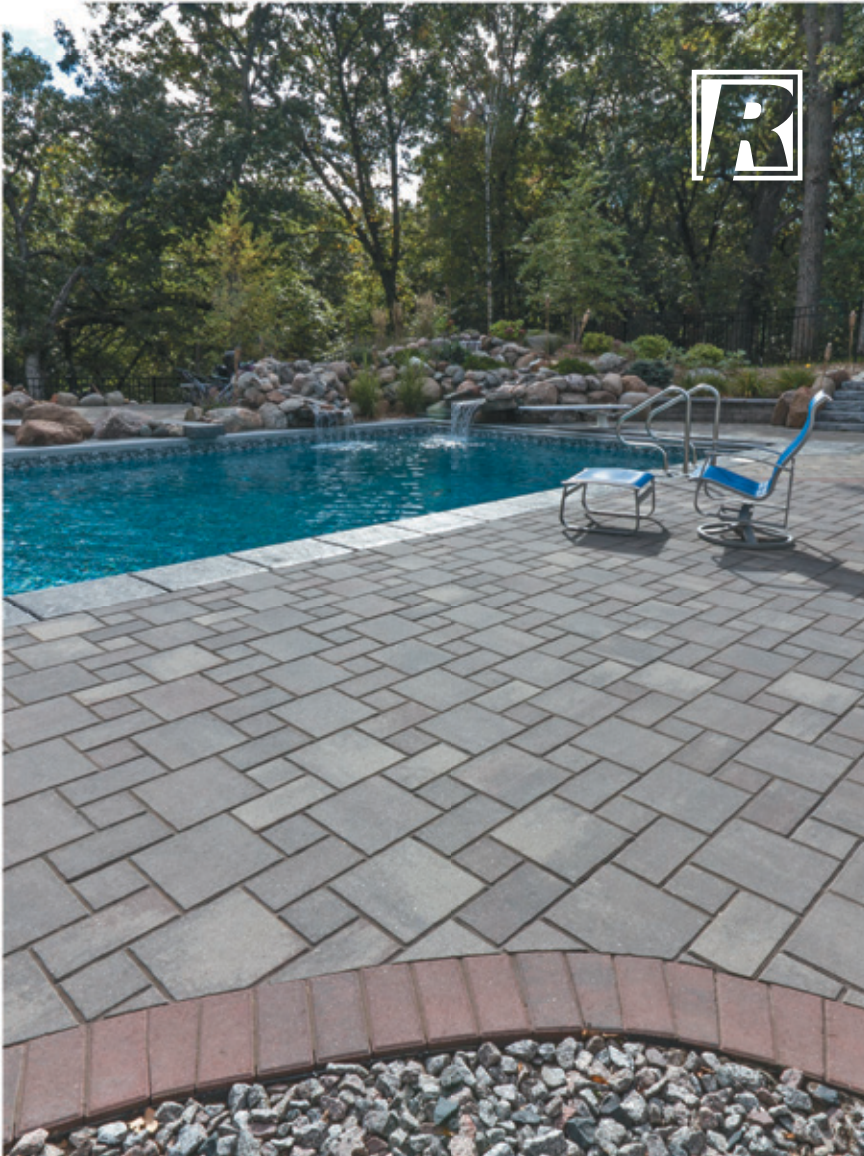



patios & paths



The buy more, get more rebate offer from Rochester Concrete Products.

The more hardscapes* you buy, the more \$ you earn.

- Earn 15¢ per sq. ft. on select pavers.
- Earn 35¢ per sq. ft. on select retaining walls.

The **BUY MORE, GET MORE HARDSCAPES REBATE OFFER** begins April 1, 2019 and ends October 31, 2019. Offer valid in the USA only. Please allow 6-8 weeks for processing.

*Rebate available only to residential property owners with projects using Minnetonka, Mezzano, Barrington, Serano and Lamont pavers, Vintage 6, Riverland and Lakeland retaining wall blocks. Visit: www.rochesterpc.com/rebate for rebate submissions and full terms and conditions.





walkways





retaining walls





barn plank

Hand-painted to recreate the look of weathered pine, each piece is so unique – no two look the same.

barn plank landscape tiles

Barn Plank tiles are manufactured with a surface applied protectant to help resist the harmful effects of time, Mother Nature, acid rain and stains.



Weathered Gray with protectant gray/black



Mahogany with protectant brown/black

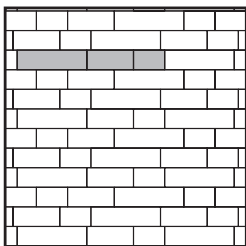
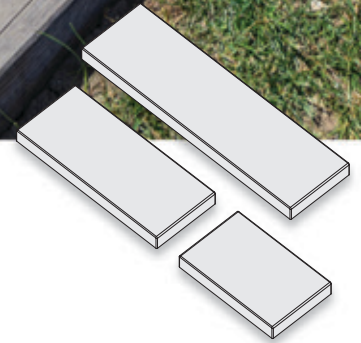

Pattern 1
S = 20.9%
M = 31.6%
L = 47.4%

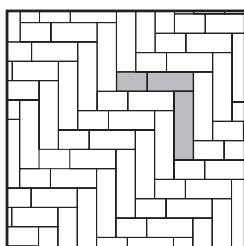

Pattern 2
S = 14.2%
M = 21.5%
L = 64.3%

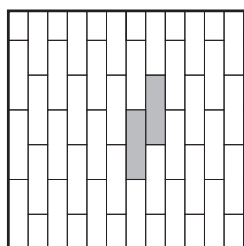

Pattern 3
L = 100%

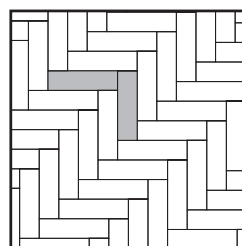

Pattern 4
L = 100%

Refer to actual product samples when making color selection.

- Deep splits, detailed grain top & sides
- For patios, paths, pool decks, caps and overlays
- Will never rot or warp
- Matching Step and Garden Wall block
- Matching Fire Pit Kit

Palletized separately:

- 15.5" W x 9.75" D x 2" H (S)
- 23.375" W x 9.75" D x 2" H (M)
- 35" W x 9.75" D x 2" H (L)

antique travertine



Silver Creek
STONWORKS

Cast from masters quarried in Tivoli, Italy – the renowned original is found on famous landmarks such as the Roman Colosseum, St. Peter's Basilica, the Getty Center and Lincoln Center.



antique travertine landscape tiles



Ivory



Natural

- Three sizes w/eighteen unique faces
- Natural travertine top and sides, honed surface, soft radius edges
- No spacers, easily gapped
- For patios, paths, pool decks, caps and overlays
- Matching Step and Garden Wall block
- Matching Fire Pit Kit

Palletized separately:

- 12" W x 24" D x 2" H
- 18" W x 24" D x 2" H
- 24" W x 24" D x 2" H
- 12" W x 24" D x 2" H (coping)

Refer to actual product samples when making color selection.

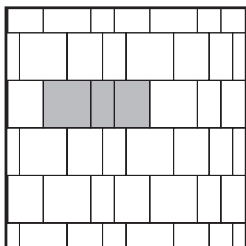
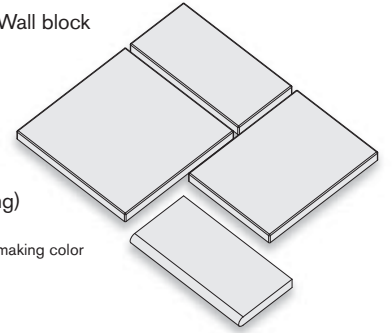

Pattern 1
 24 x 12" = 22.26%
 24 x 18" = 33.33%
 24 x 24" = 44.4%

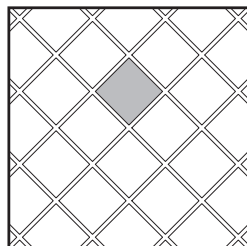

Pattern 2
 24 x 24" = 100%

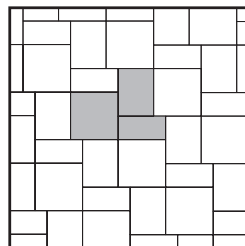

Pattern 3
 24 x 12" = 22.26%
 24 x 18" = 33.33%
 24 x 24" = 44.4%

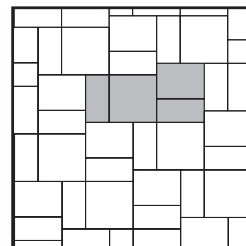

Pattern 4
 24 x 12" = 36.2%
 24 x 18" = 27.3%
 24 x 24" = 36.5%

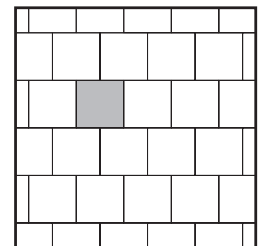

Pattern 5
 24 x 24" = 100%

A large outdoor swimming pool with a stone patio, lounge chairs, and a lake in the background. The pool is surrounded by a stone patio made of light-colored, rectangular tiles. There are several lounge chairs on the patio. In the background, there is a lake with a boat and some trees. The sky is blue with some clouds.

slate

Slate's rich texture comes from actual stone quarried in the Northeastern U.S.A., where stone craftsmanship dates back to the early 1800's. Like natural slate, no two are exactly the same.

slate landscape tiles

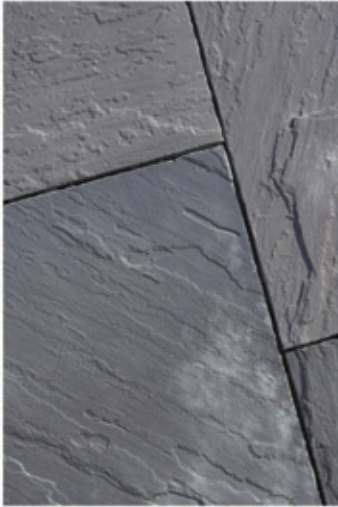

Bluestone
charcoal/light charcoal



Cream
white/sandstone



Fond du Lac
gray/charcoal/sandstone



Western Buff
sandstone/brown

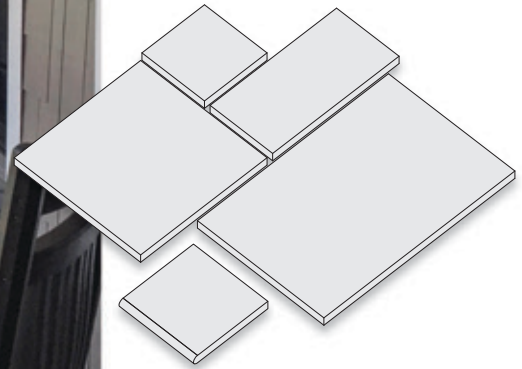

- Detailed slate top, chiseled sides
- No spacers, easily gapped
- Lays quickly, patterned or random
- For paths, patios, pools, caps and overlays
- Unique 24" x 36" XL slab
- Matching coping

Palletized separately:

- 12" W x 12" D x 1.5" H
- 12" W x 24" D x 1.5" H
- 24" W x 24" D x 1.5" H
- 36" W x 24" D x 1.5" H (XL)
- 14" W x 14" D x 1.5" H (coping)

Refer to actual product samples when making color selection.

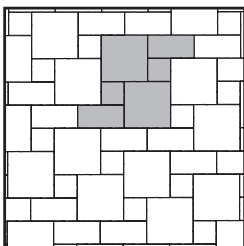

Pattern 1
12 x 12" = 14%
24 x 12" = 29%
24 x 24" = 57%

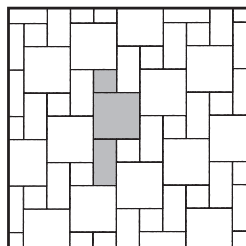

Pattern 2
12 x 12" = 14%
24 x 12" = 29%
24 x 24" = 57%

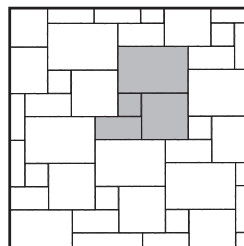

Pattern 3
12 x 12" = 7.69%
24 x 12" = 15.39%
24 x 24" = 30.77%
24 x 36" = 46.15%

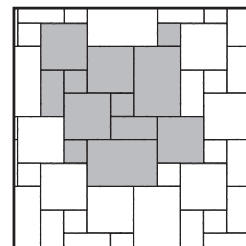

Pattern 4
12 x 12" = 11.1%
24 x 12" = 11.1%
24 x 24" = 44.4%
24 x 36" = 33.3%



broadmour plank

Broadmour Plank's shape makes it a high flow rate, eco-friendly permeable paver.

broadmour plank



Beechwood
brown/charcoal/buff



Cascade
gray/charcoal



Natural
gray



Onyx with KolorLast

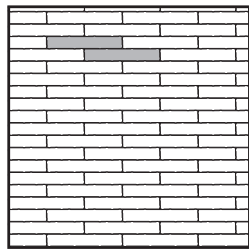

Running Bond

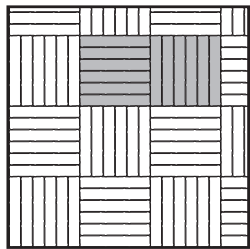

Parquet

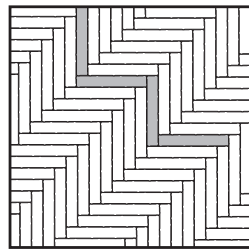

Herringbone

- Smooth top, squared face
- Small auto-spacer
- For patios, paths and pool decks
- High flow rate eco/permeable

One size:
- 18" W x 3" D x 4" H

Refer to actual product samples when making color selection.

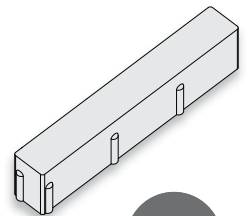

permeable

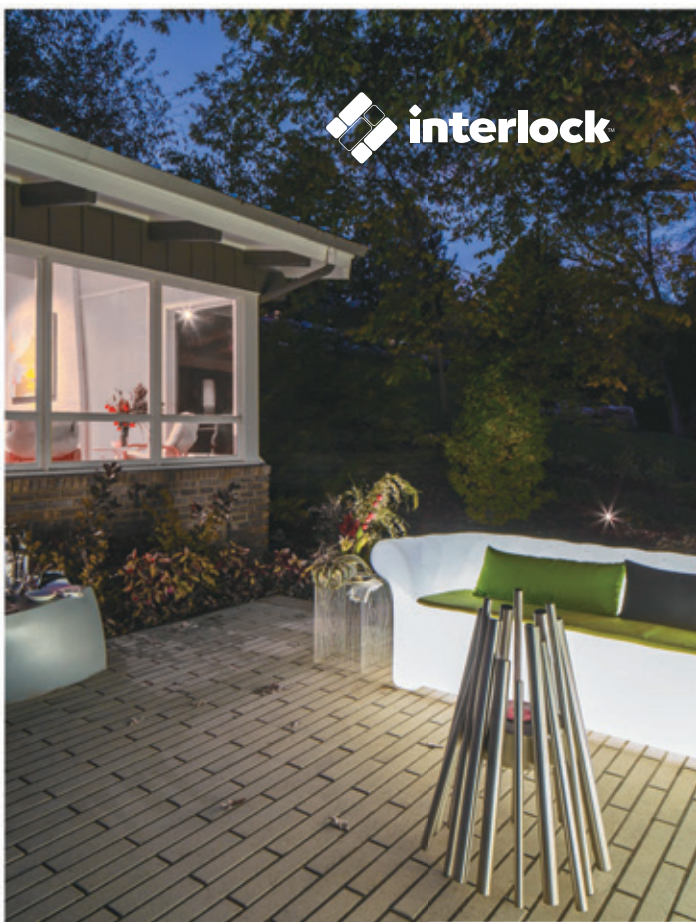



 **interlock**

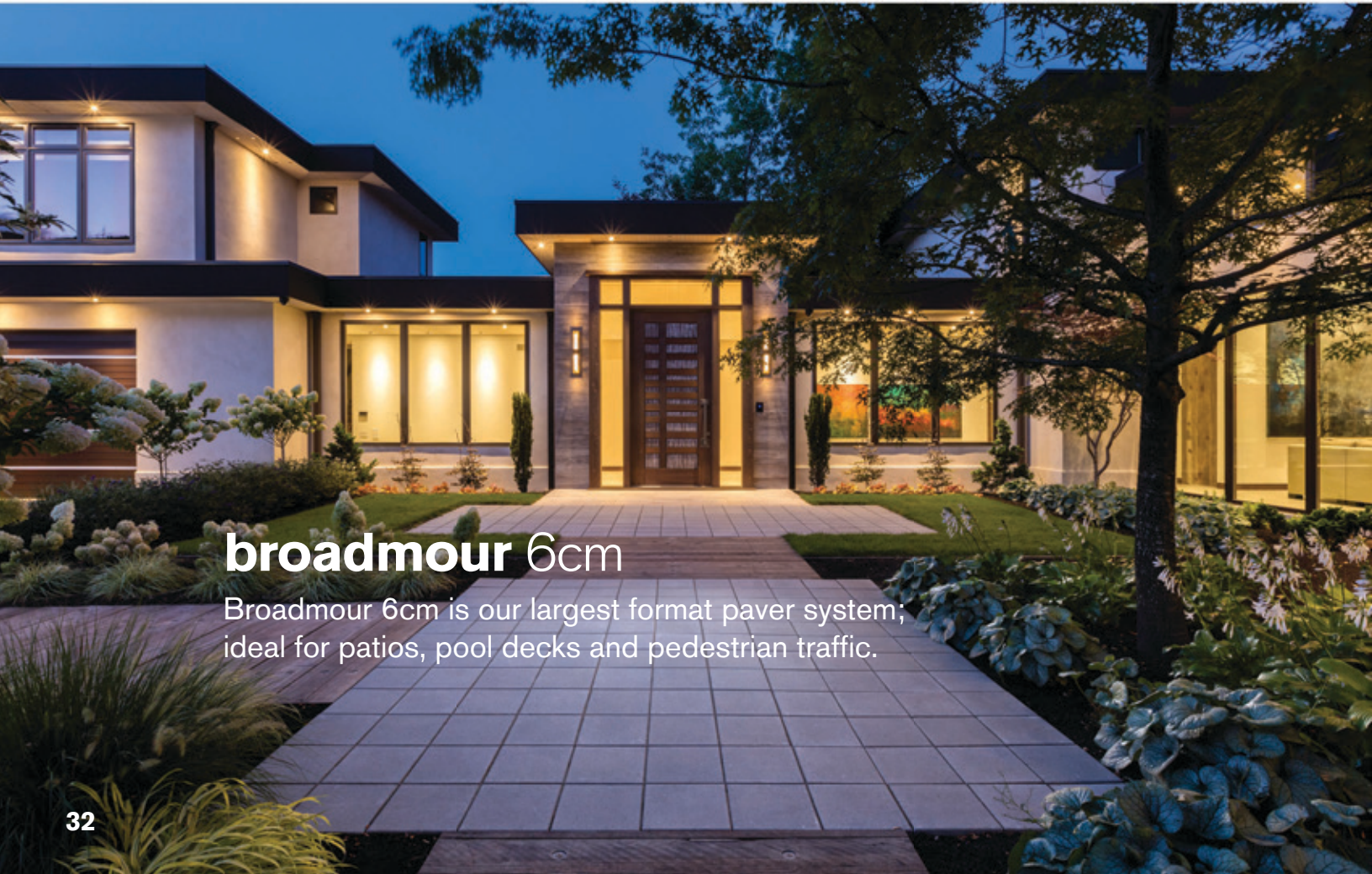

broadmour 6cm

Broadmour 6cm is our largest format paver system; ideal for patios, pool decks and pedestrian traffic.



Beechwood with KolorLast
brown/charcoal/buff



Cascade
gray/charcoal



Natural
gray



Onyx 6cm with KolorLast



broadmour 10cm

Broadmour 10cm is a high performance paver for extreme applications.

- Smooth top, squared face
- Chamfered edge
- Small auto-spacer
- For patios, paths, pool decks and drives

Broadmour 6cm (separate pallets)

- 6" W x 12" D x 2.375" H
- 12" W x 12" D x 2.375" H
- 12" W x 24" D x 2.375" H
- 24" W x 24" D x 2.375" H

Broadmour 10cm (separate pallets)

- 6" W x 12" D x 4" H
- 12" W x 12" D x 4" H
- 12" W x 24" D x 4" H
- 18" W x 3" D x 4" H (Plank)

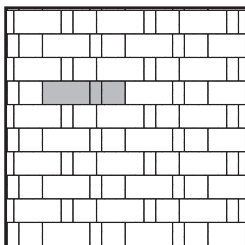
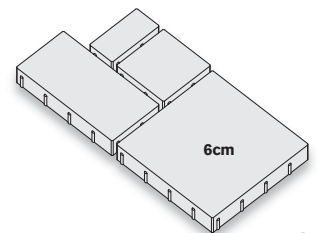
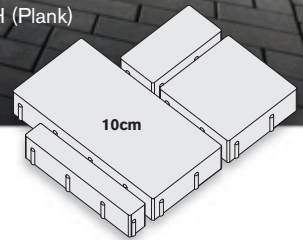

Pattern 1
Small = 14.3%
Medium = 28.57%
Large = 57.14%

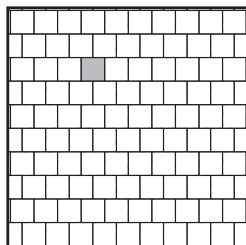

Pattern 2
Medium = 100%

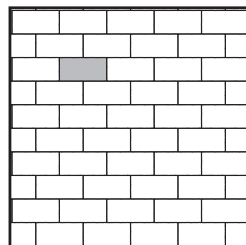

Pattern 3
Large = 100%

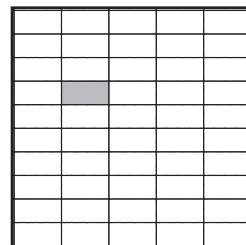

Pattern 4
Large = 100%

Colors shown with wet-look sealer. Refer to actual product samples when making color selection.
Plank paver not suitable for vehicular applications.



barrington



Buy More, Get More – 15¢/sq. ft. Rebate

barrington paver/slab



Antique Brown
brown/charcoal/desert buff



Beechwood w or w/o KolorLast
brown/charcoal/buff



Bluestone w or w/o KolorLast
gray/brown/charcoal



Cascade
gray/black



Santa Fe w or w/o KolorLast
gray/sandstone/brown



Brown*



Buff*



Onyx* with Kolorlast

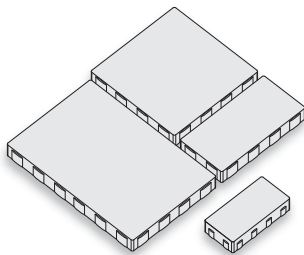

- Smooth top, squared face
- Chamfered/irregular edge
- Small auto-spacer
- For patios, paths and pool decks

Three-piece, one-pallet system:
 - 8" W x 16" D x 2.375" H (S)
 - 16" W x 16" D x 2.375" H (M)
 - 24" W x 16" D x 2.375" H (L)

* Solid colors all on separate pallets:
 - 6" W x 12" D x 2.375" H



Colors shown with wet-look sealer. Refer to actual product samples when making color selection.

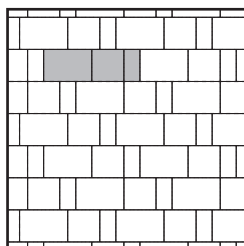

Pattern 1
S = 16.6%
M = 33.33%
L = 50.7%

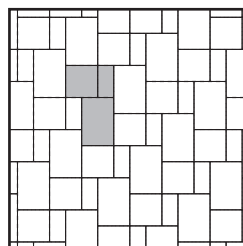

Pattern 2
S = 16.6%
M = 33.33%
L = 50.7%

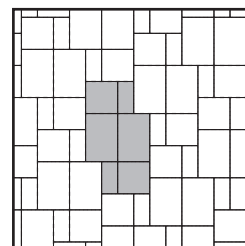

Pattern 3
S = 16.6%
M = 33.33%
L = 50.7%

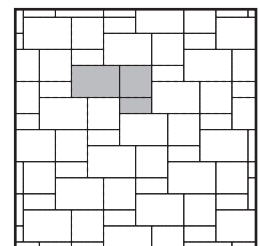

Pattern 4
S = 16.6%
M = 33.33%
L = 50.7%



minnetonka

Buy More, Get More – 15¢/sq. ft. Rebate

minnetonka paver/slab



Antique Brown
brown/charcoal/desert buff



Beechwood w or w/o KolorLast
brown/charcoal/buff



Bluestone w or w/o KolorLast
gray/brown/charcoal



Cascade
gray/black

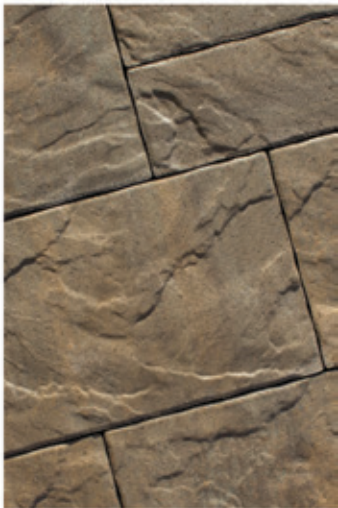

Santa Fe w or w/o KolorLast
gray/sandstone/brown

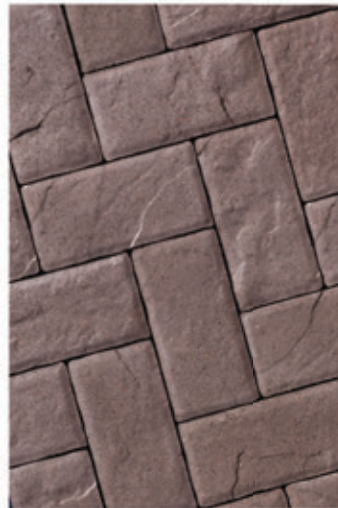

Brown*



Buff*



Onyx* with Kolorlast

Colors shown with wet-look sealer. Refer to actual product samples when making color selection.

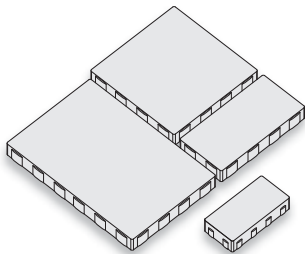

- Slate texture top, squared face
- Chamfered/irregular edge
- Small auto-spacer
- For patios, paths and pool decks

Three-piece, one-pallet system:

- 8" W x 16" D x 2.375" H (S)
- 16" W x 16" D x 2.375" H (M)
- 24" W x 16" D x 2.375" H (L)

* Solid colors all on separate pallets:

- 6" W x 12" D x 2.375" H



Colors shown with wet-look sealer. Refer to actual product samples when making color selection.

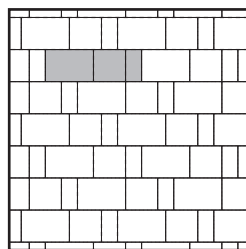

Pattern 1
S = 16.6%
M = 33.33%
L = 50.7%

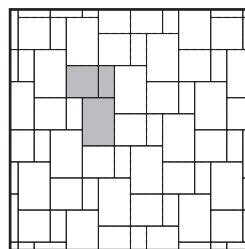

Pattern 2
S = 16.6%
M = 33.33%
L = 50.7%

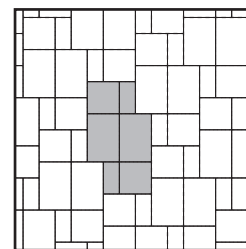

Pattern 3
S = 16.6%
M = 33.33%
L = 50.7%

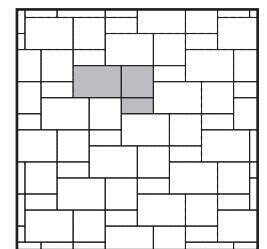

Pattern 4
S = 16.6%
M = 33.33%
L = 50.7%



serano

Serano's 6 x 12 colors create very appealing insets, borders and edge details.



interlock

Buy More, Get More – 15¢/sq. ft. Rebate

serano paver



Antique Brown
brown/charcoal/desert buff



Beechwood w or w/o KolorLast
brown/charcoal/buff



Bluestone w or w/o KolorLast
gray/brown/charcoal



Cascade
gray/black



Santa Fe w or w/o KolorLast
gray/sandstone/brown



Brown*



Buff*



Onyx* with Kolorlast

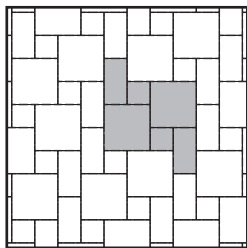

Pattern 1
S = 14%
M = 29%
L = 57%

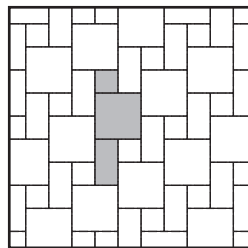

Pattern 2
S = 14%
M = 29%
L = 57%

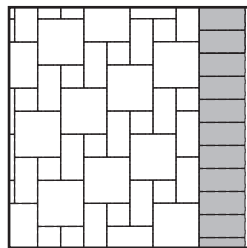

Pattern 2
Solder Course Border

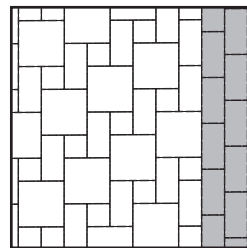

Pattern 2
Double Sailor Border



- Smooth top, contemporary style
- Chamfered, irregular edge
- Auto spacers, wider joint
- Lays quickly, patterned or random
- Suitable for vehicular applications

Three-piece, one-pallet system:
- 6" W x 6" D x 2.375" H (S)
- 6" W x 12" D x 2.375" H (M)
- 12" W x 12" D x 2.375" H (L)

* Solid colors all on separate pallets
- 6" W x 12" D x 2.375" H

Colors shown with wet-look sealer. Refer to actual product samples when making color selection.

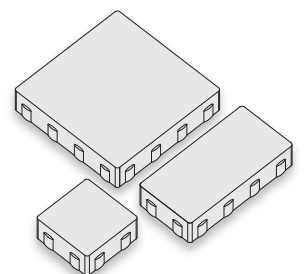

mezzano

Buy More, Get More – 15¢/sq. ft. Rebate

mezzano paver



Antique Brown
brown/charcoal/desert buff



Beechwood w or w/o KolorLast
brown/charcoal/buff



Bluestone w or w/o KolorLast
gray/brown/charcoal



Cascade
gray/black



Santa Fe w or w/o KolorLast
gray/sandstone/brown



Brown*



Buff*



Onyx* with Kolorlast

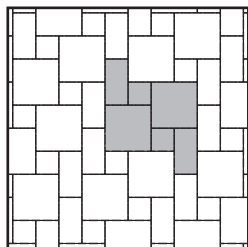

Pattern 1
S = 14%
M = 29%
L = 57%

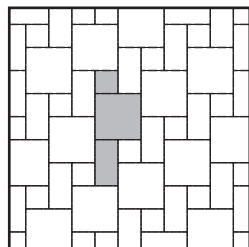

Pattern 2
S = 14%
M = 29%
L = 57%

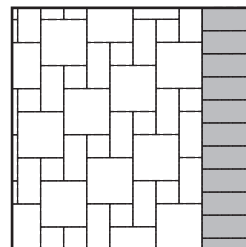

Pattern 2
Solder Course Border

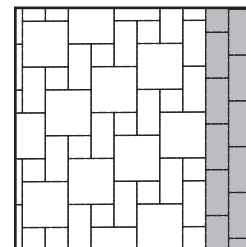

Pattern 2
Double Sailor Border

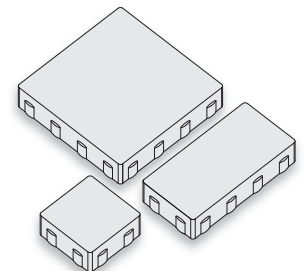

- Slate top, old worldly style
- Chamfered, irregular edge
- Auto spacers, wider joint
- Lays quickly, patterned or random
- Suitable for vehicular applications

Three-piece, one-pallet system:
- 6" W x 6" D x 2.375" H (S)
- 6" W x 12" D x 2.375" H (M)
- 12" W x 12" D x 2.375" H (L)

* Solid colors all on separate pallets
- 6" W x 12" D x 2.375" H

Colors shown with wet-look sealer. Refer to actual product samples when making color selection.





american brick

american brick paver



Buff with Kolorlast



Brown with Kolorlast



Heritage Blend with Kolorlast

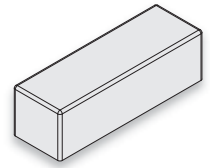

- Subtle textured surface, radius edges and corners
- No auto spacer, tight joints
- Ideal for accents, banding, borders and edging

One size, multiple unique faces:
- 2.5" W x 8" D x 2.375" H



Onyx with Kolorlast



Tuscan Red with Kolorlast



Colors shown with wet-look sealer. Refer to actual product samples when making color selection.





cobble stone

Cobble Stone's wide joint makes it a high flow rate, eco-friendly permeable paver.

cobble stone paver



Beechwood
brown/charcoal/buff

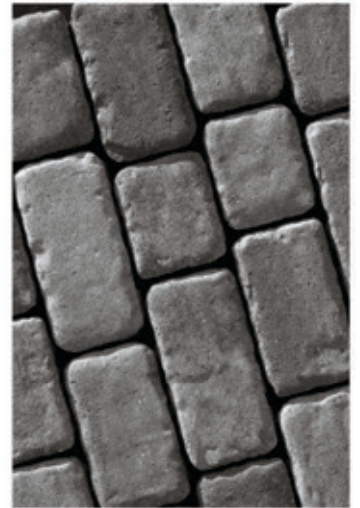

Moonlight Gray
charcoal/natural



Onyx with KolorLast



- Texture top, irregular edge
- For patios, paths and drives
- Open joint; high flow rate, eco/permeable

Four-piece, one-pallet system:
- 7.125" W x 5.875" D x 3.125" H
- 8.875" W x 5.875" D x 3.125" H
- 10.375" W x 5.875" D x 3.125" H
- 11.875" W x 5.875" D x 3.125" H

permeable

Colors shown with wet-look sealer. Refer to actual product samples when making color selection.



lamont

Buy More, Get More – 15¢/sq. ft. Rebate

Iamont paver



Antique Brown
brown/charcoal/desert buff



Beechwood
brown/charcoal/buff



Santa Fe
gray/sandstone/brown



Sierra Gray
charcoal/desert buff



Brown*



Desert Buff*



Onyx*

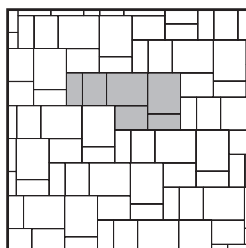
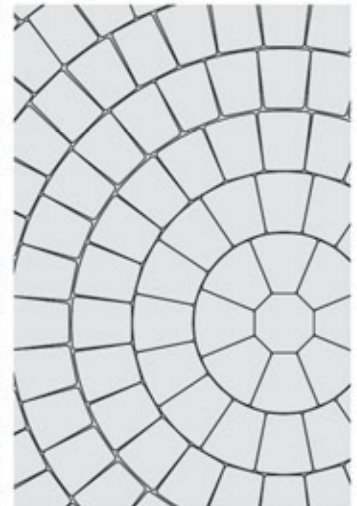

Pattern 1
4 x 8" = 20%
6 x 8" = 30%
10 x 8" = 50%

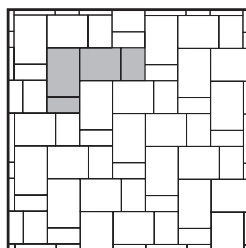

Pattern 2
4 x 8" = 12%
6 x 8" = 19%
10 x 8" = 31%
12 x 8" = 38%

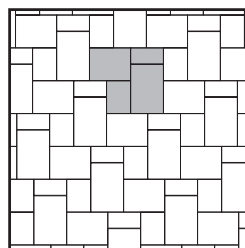

Pattern 3
4 x 8" = 12%
6 x 8" = 19%
10 x 8" = 31%
12 x 8" = 38%

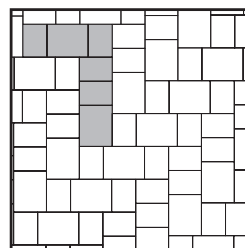

Pattern 4
6 x 8" = 45%
10 x 8" = 55%

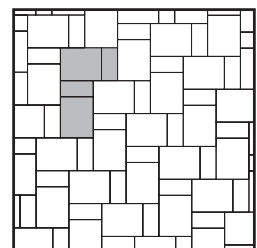

Pattern 5
4 x 8" = 29%
10 x 8" = 71%

- Tumbled/aged appearance
- Small auto-spacer
- For patios, paths and drives
- Matching circle kit

Four sizes on separate pallets:
- 4" W x 8" D x 2.375" H*
- 6" W x 8" D x 2.375" H*
- 10" W x 8" D x 2.375" H
- 12" W x 8" D x 2.375" H

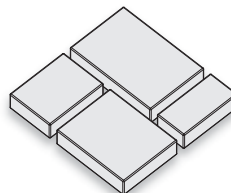

*Also available in solid colors

Colors shown with wet-look sealer. Refer to actual product samples when making color selection.

flagstone



flagstone paver



Santa Fe
gray/sandstone/brown



Antique Brown
brown/charcoal/desert buff



Sierra Gray
charcoal/desert buff

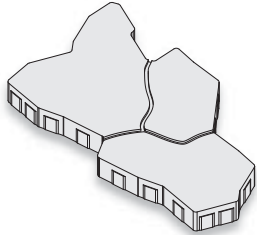

- Narrow spacer/wide false joint
- Textured top, beveled edge
- Small auto-spacer
- For patios, paths and pool decks

One shape, six unique slate faces:
- 2.375" H, 1.58 sq. ft. ea.

Colors shown with wet-look sealer. Refer to actual product samples when making color selection.





 **interlock**



colonial



Antique Copper
red/charcoal/buff



Beechwood
brown/charcoal/buff



Carmel
brown/buff



Moonlight Gray
charcoal/natural



Brown*



Buff*



Onyx* with KolorLast

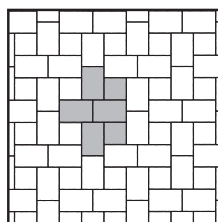
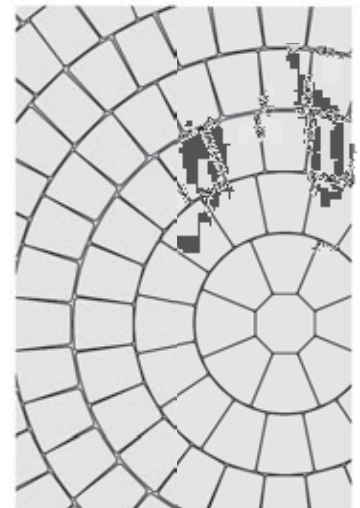

Pattern 1
Square = 25%
Rectangle = 75%

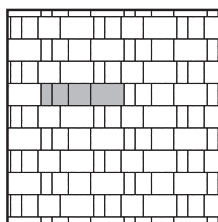

Pattern 2
Half square = 13.37%
3/4 square = 19.75%
Square = 26.75%
Rectangle = 40.13%

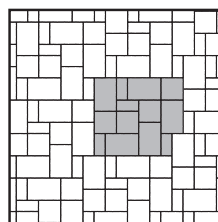

Pattern 3
Half square = 14.81%
Square = 29.63%
Rectangle = 55.56%

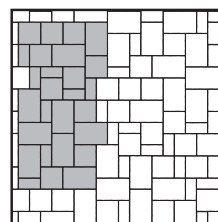

Pattern 4
Half square = 14.55%
Square = 36.36%
Rectangle = 49.09%

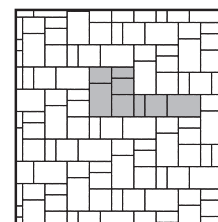

Pattern 5
Half square = 13.37%
3/4 square = 19.75%
Square = 26.75%
Rectangle = 40.13%

- Smooth/dimpled top, smoother edge
- Small auto-spacer
- For patios, paths, pool decks and drives
- Matching circle kit

*Also available in Brown, Buff and Onyx
Colors shown with wet-look sealer. Refer to actual product samples when making color selection.

- Colonial 6cm**, all on separate pallets
- 6.3" W x 3.15" D x 2.375" H (Half square)
 - 6.3" W x 6.3" D x 2.375" H (Square)
 - 6.3" W x 4.65" D x 2.375" H (3/4 square)*
 - 6.3" W x 9.45" D x 2.375" H (Rectangle)*

- Colonial 8cm**, all on separate pallets
- 6.3" W x 6.3" D x 3.125" H (Square)*
 - 6.3" W x 9.45" D x 3.125" H (Rectangle)*

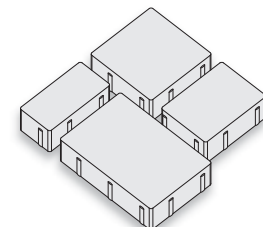



holland and holland-eco



Antique Copper
red/charcoal/buff



Beechwood*
brown/charcoal/buff



Carmel*
brown/buff



Moonlight Gray
charcoal/natural



Rosewood
red/charcoal



Brown



Buff



Onyx with KolorLast

Colors shown with wet-look sealer. Refer to actual product samples when making color selection.

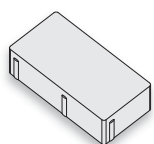
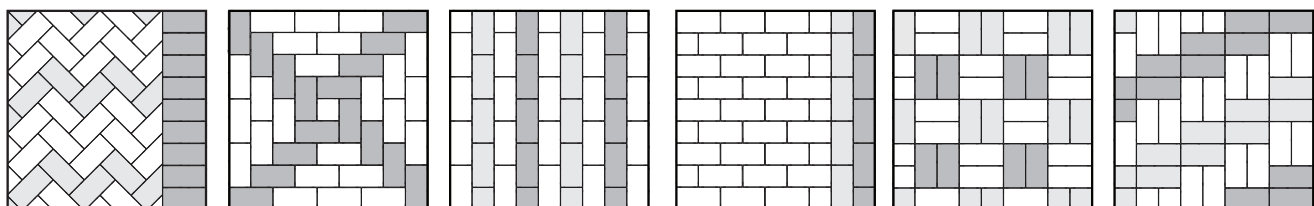

Holland (6cm)

- Larger than typical Hollands
- Smooth top, beveled edge
- Small auto-spacer
- For patios, paths, pool decks and drives



One size, all colors shown:
- 8.5" W x 4.25" D x 2.375" H

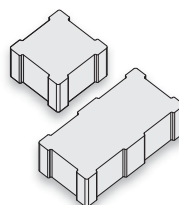

Holland-Eco (8cm)

- Wide auto-spacer; high flow rate eco/permeable
- Ideal for vehicular applications
- Machine layable
- * In Beechwood or Carmel

Two sizes (configurable layers):
- 9.75" W x 4.875" D x 3.125" H
- 4.875" W x 4.875" D x 3.125" H

travertine garden wall

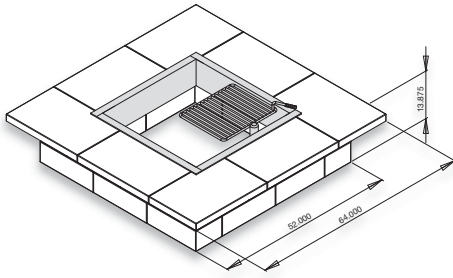

Travertine Fire Pit Kit

- Two block courses plus cap
- Four-piece heavy gauge steel insert protects block
- Optional, removable swivel cooking grate

Travertine Step

- 48" W x 18" D x 5.75" H

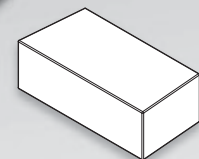

Travertine Garden Wall
- 18/16.5" W x 9" D x 6" H

barn plank garden wall

Mahogany



Weathered Gray



Barn Plank Step
- 48" W x 18" D x 5.75" H

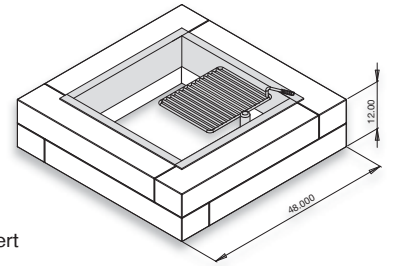

Barn Plank Fire Pit Kit

- Four-piece heavy guage steel insert protects block
- Optional, removable swivel cooking grate



Barn Plank Garden Wall
- 40" W x 8" D x 6" H

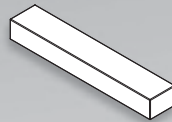

barn plank garden wall





ROCKWOOD
RETAINING WALLS
A better way.

vintage 6



Buy More, Get More – 35¢/sq. ft. Rebate

vintage 6 retaining wall



Bluestone
gray/brown/charcoal



Santa Fe
gray/sandstone/brown



Beechwood
brown/charcoal/buff



Desert Buff

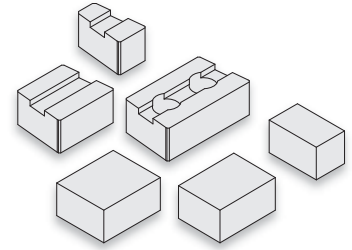

- Tumbled, aged appearance
- Vertical, freestanding or retaining walls
- Builds straight or 8' radius without cutting
- Cap with 4" Universal, 3" Universal, 13" Tumbled, Riverland or Chiseled cap

Three-piece system on one pallet:

- 6" W x 10" D x 6" H (small)
- 12" W x 10" D x 6" H (medium)
- 18" W x 10" D x 6" H (large)

- 12" W x 9" D x 6" H (pillar/corner block)
- 6" W x 10" D x 6" H (small end block)
- 12" W x 10" D x 6" H (large end block)

Refer to actual product samples when making color selection.





classic® 8 chiseled face



classic 8 chiseled face retaining wall

ROCKWOOD
RETAINING WALLS
A better way.™

- The look of handcrafted stone
- Efficient to build, one-unit system
- Strong and versatile
- Matching base and corner blocks
- Cap with 4" Universal or Chiseled Cap

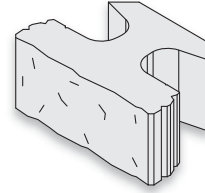

One size, 0.5" setback:
- 18" W x 12" D x 8" H

Refer to actual product samples when making color selection.



Bluestone
gray/brown/charcoal



Gray



Santa Fe
gray/sandstone/brown



- Extremely versatile systems build vertical, freestanding retaining walls and outdoor living features
- Cap with 3" or Chiseled Cap

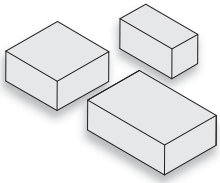

Lakeland (square units):

- Builds straight walls and 90° corners
- Available tumbled
- Available smooth (large only)

- 4" W x 8" D x 4" H (small)
- 8" W x 8" D x 4" H (medium)
- 12" W x 8" D x 4" H (large)

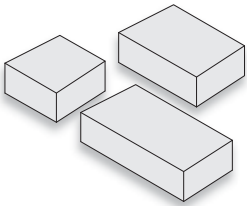

Riverland (angled units):

- Builds 8' radius walls without cutting
- Available tumbled or smooth

- 8" W x 8" D x 4" H (small)
- 12" W x 8" D x 4" H (medium)
- 16" W x 8" D x 4" H (large)

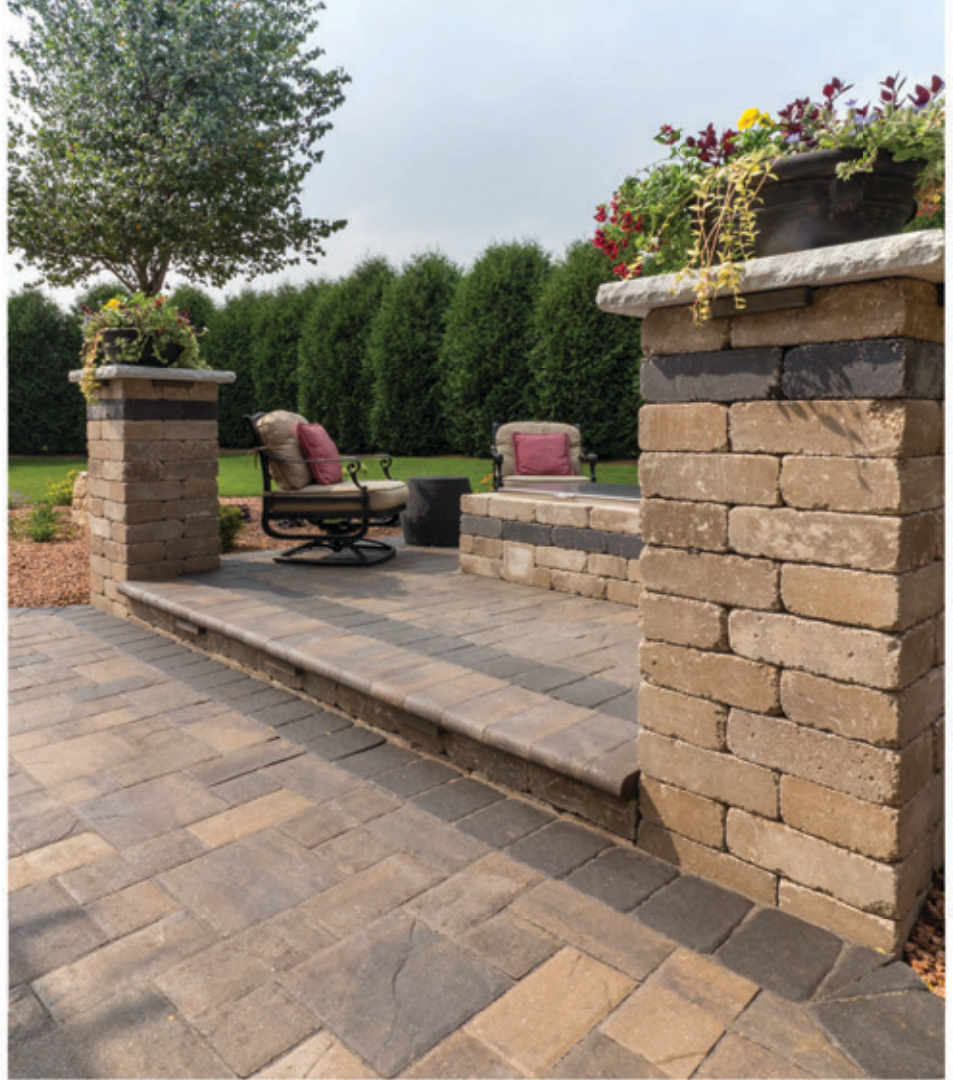

Buy More, Get More – 35¢/sq. ft. Rebate

lakeland and riverland retaining walls



Beechwood
brown/charcoal/buff



Bluestone
gray/brown/charcoal



Desert
sandstone/blush/brown



Onyx (avail. non-tumbled Lakeland all sizes)



Santa Fe
gray/sandstone/brown

ROCKWOOD®
RETAINING WALLS
A better way.™



lakeland



classic colonial[®] 6 and 8

classic colonial 6 and 8 retaining walls



Bluestone
gray/brown/charcoal



Sandstone/Brown



Santa Fe
gray/sandstone/brown

- Multi-unit appearance, rustic face
- Efficient to build
- Strong and versatile
- Matching base, corner and half blocks
- Cap with 4" Universal, 3" Universal or Chiseled Cap
- 18" and 6/12" faces on separate pallets

Refer to actual product samples when making color selection.

Classic Colonial 6
- 18" W x 12" D x 6" H
- 0.75" setback

Classic Colonial 8
- 18" W x 12" D x 8" H
- 1.0" setback
- Special order

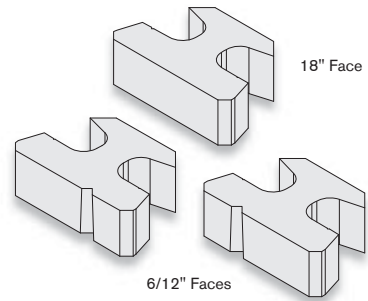

4" Universal Cap Block
- Split-face front/back, trapezoid design
- Seven colors choices
- 18" W x 10.5" D x 4" H

ROCKWOOD
RETAINING WALLS
A better way.

ROCKWOOD[®]
RETAINING WALLS
A better way.



Rockwood's Classic install guide: www.rochesterpc.com/install



classic[®] 6 and 8

classic 6 and 8 retaining walls



Brown



Bluestone
gray/brown/charcoal



Charcoal



Gray



Sandstone/Brown



Sandstone



Santa Fe
gray/sandstone/brown

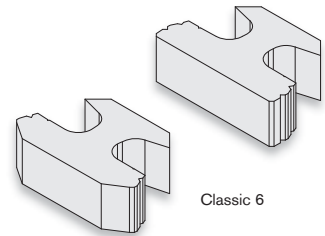

Classic 6

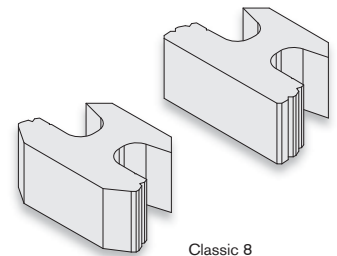

Classic 8



- Straight or beveled face options
- Efficient to build, one-unit system
- Strong and versatile
- Matching base, corner and half blocks
- Cap with 4" Universal, 3" Universal or Chiseled Cap

Classic 6

- 18" W x 12" D x 6" H
- 0.75" setback
- Not available in Brown

Classic 8

- 18" W x 12" D x 8" H
- 1.0" setback
- Not available in Bluestone, Charcoal or Santa Fe

Refer to actual product samples when making color selection.

stonegate retaining wall



Beechwood
brown/charcoal/buff



Bluestone
gray/brown/charcoal



Santa Fe
gray/sandstone/brown



stonegate

- Tumbled, aged appearance
- Strong and versatile drystack/pin connection method
- Vertical or adjustable setback
- Cap with Lakeland or Chiseled Cap

Three-piece, one pallet system:

- 6" W x 10" D x 6" H
- 12" W x 10" D x 6" H
- 16" W x 10" D x 6" H



Stonegate requires two shouldered pins per unit.



compac retaining wall

Refer to actual product samples when making color selection.



Brown



Gray



Sandstone



Featuring unrivaled aesthetic options, cost saving versatility and proven wall performance. Compac's lighter weight and shorter tail design make it easy to handle.

- Cap with 4" Universal or Chiseled Cap

Straight-split face only:

- 1.0" set back
- 18" W x 12" D x 8" H
- 18" W x 9" D x 8" H (Corner Block)



Compac requires two non-shoulder pins per unit.





Irregular Steps

- Six unique shapes in 5.5" or 7" rise
- 42" to 60" widths x 17" x 28" depths



kodah wall

Outcropping Wall

- Strong, wet cast wall blocks for serious performance and curb appeal
- 15° setback
- Lifting device required

Fourteen unique shapes, multiple pallets:

- 6", 12", 18" and 24" heights x 24" to 72" widths
- 30" x 48" x 12" H corner block

ROSETTA
THE LOOK AND FEEL OF NATURE

outcropping wall



Copper Canyon



Fond du Lac



Pacific Gray



belvedere wall

3" Universal Cap

- Two-sided split-face, beveled edge
- Six color options, 70
- 12" W x 12" D x 3" H

Kodah Wall

- Two-sided wet cast blocks create unique garden and freestanding vertical walls
- Strong and versatile retaining wall system

Four sizes on one pallet:

- 12, 21, 30 and 42" lengths x 10.5" D x 6" H

Corner/end block:

- 21" W x 10.5" D x 6" H

Belvedere Wall

- Strong and versatile retaining wall system with the look of weathered stone
- Two-sided units create vertical pillars, freestanding walls and outdoor features

Six unique shapes, one pallet system:

- 8" x 9", 12" x 9" and 18" x 9" units in 3 and 6" heights

Matching corner/end, pillar cap and kits:

- 15" W x 9" D x (3" and 6" H) (corner/end)
- 27" W x 27" D x 2.5" H (pillar cap)
- 24" W x 24" D x 36" H (pillar kit)
- 58" x 14.5" (fire ring kit)

Refer to actual product samples when making color selection.

sapphire retaining wall



Sapphire's radius bottom eliminates the need for cleaning courses, saving time and hassle.

- Straight face, smooth top
- Partial cores equal less weight
- Efficient to build, rear-lip system
- Cap with 4" Universal, 3", 13" or Chiseled Cap

Rear lip system, 1" setback:
- 17.25" W x 12" D x 6"



Beechwood brown/charcoal/buff



Gray



Sandstone



Santa Fe gray/sandstone/brown

ROCKWOOD[®]
RETAINING WALLS
A better way™

- 4" Universal Cap**
- Two-sided split face
 - 18" W x 4" D x 4" H

sapphire 6

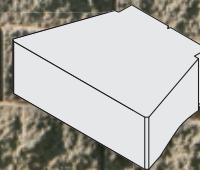

cottage stone retaining wall



Brown



Charcoal



Gray



Sandstone



Sandstone/Brown

- Beveled face creates pleasing garden and low retaining walls, tree rings and planters
- Curved bottom aids fast install
- Cap with mini-cap

Rear lip system, 0.5" setback:
- 12" W x 8.5" D x 4" H

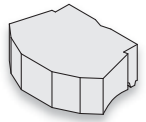

cottage stone

Mini-Cap

- Two-sided split face, beveled edge
- Five color choices
- 8" W x 9" D x 3" H

chiseled steps



Silver Creek
STONEWORKS

Chiseled Steps

- The look of handcrafted limestone in two styles;
 - Chiseled one side, smooth top
 - Chiseled three sides, rough top

- 48" W x 18" D x 5.75" H



Indiana Limestone

Shown in 3-sided



Bluestone

Shown in 3-sided



Buff

Shown in 3-sided



Available in smooth-top with chiseled face or, rough-top with chiseled face and sides.





grand step

steps

Big Step

- Split face front
- In Bluestone, Gray, Santa Fe, Sandstone and Sandstone/Brown

- 16" W x 16" D x 6" H

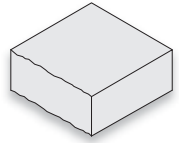

Grand Step

- Reversible faces

- 48" W x 18" D x 5.75" H

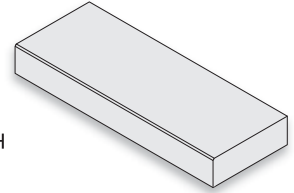

Santa Fe



Natural



Buff



Straight split riser on one side.

Charcoal



Beechwood



Smooth riser w/bevel top on the other.



Pillar, fire ring and seat wall caps are wet cast reproductions of handcrafted originals.



chiseled caps



Silver Creek
STONEWORKS



Indiana Limestone



Bluestone



Buff

- The look of handcrafted limestone with hewn top and chiseled sides
- Use for pillars, seat/retaining walls, fire rings and custom outdoor features

a) Fire Ring Cap

- Chiseled outside edge
- 8-piece set
- 10" D x 2.25" H

b) Straight Wall Caps

- Chiseled two or three sides
- 24" W x 12" D x 2.25" H

c) Radius Wall Caps

- Chiseled two or three sides
- 18.75" W x 12" D x 2.25" H

d) Pillar Caps

- Chiseled four sides
- 25" W x 25" D x 2.25" H
- 30" W x 30" D x 2.25" H

e) Bar Top

- Chiseled front/back, smooth ends
- Chiseled three sides, smooth end
- 36" W x 48" D x 2.25" H

f) Octagon Cap

- Chiseled edge
- 36" W x 6" D x 2.25" H

Refer to actual product samples when making color selection.

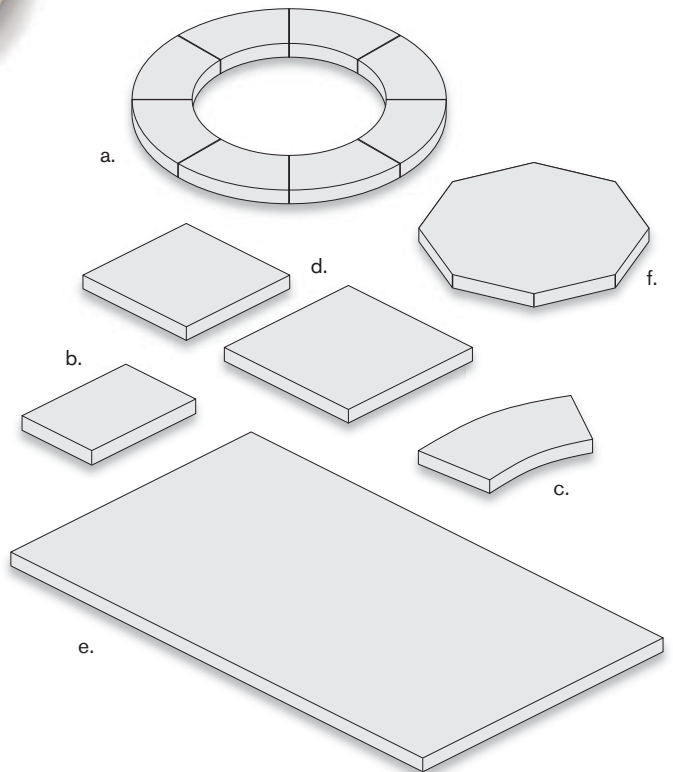



Silver Creek
STONEWORKS

- Strong, wet cast reproductions of handcrafted slate and travertine originals
- Full radius front, detailed tops

Slate Coping

- Available in colors shown on page 29
- 14" W x 14" D x 1.5" H

Travertine Coping

- Available in Ivory or Natural color
- 12" W x 24" D x 2" H

Refer to actual product samples when making color selection.

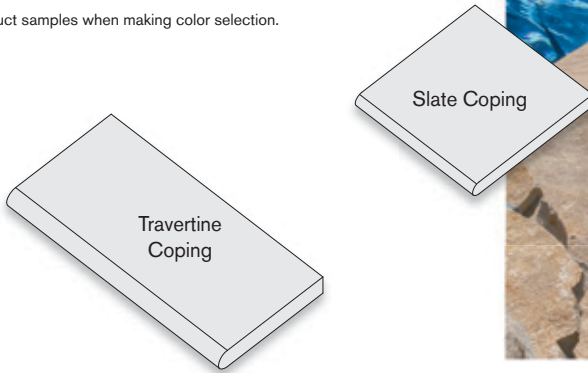

bullnose and coping



Sierra Gray



Antique Brown

- Designed for treads, coping, seat walls and accents
- Full radius front, smooth top/sides
- Also available in Brown and Onyx

- 6" W x 12" D x 2.375" H

Refer to actual product samples when making color selection.



Beechwood



Santa Fe



Desert Buff



bullnose paver



Silver Creek
STONEWORKS

stepping stones

stepping stones

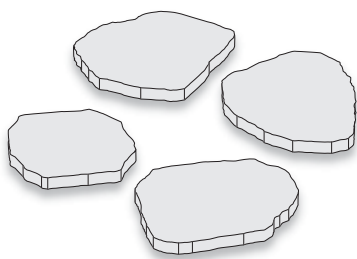

- Strong, wet cast reproductions of handcrafted limestone originals
- Four unique shapes, chiseled edge
- Sold in sets

- 1.75" H, (3.75 sq. ft. ea. ave.)

Refer to actual product samples when making color selection.



tumbled granite edger

Smooth sides, split-face top, tumbled:
 - 12" W x 4" D x 4" H

classic® edger

Smaller profile than typical edgers:
 - 10" W x 2.75" D x 4" H



ROCKWOOD
 RETAINING WALLS
A better way.™

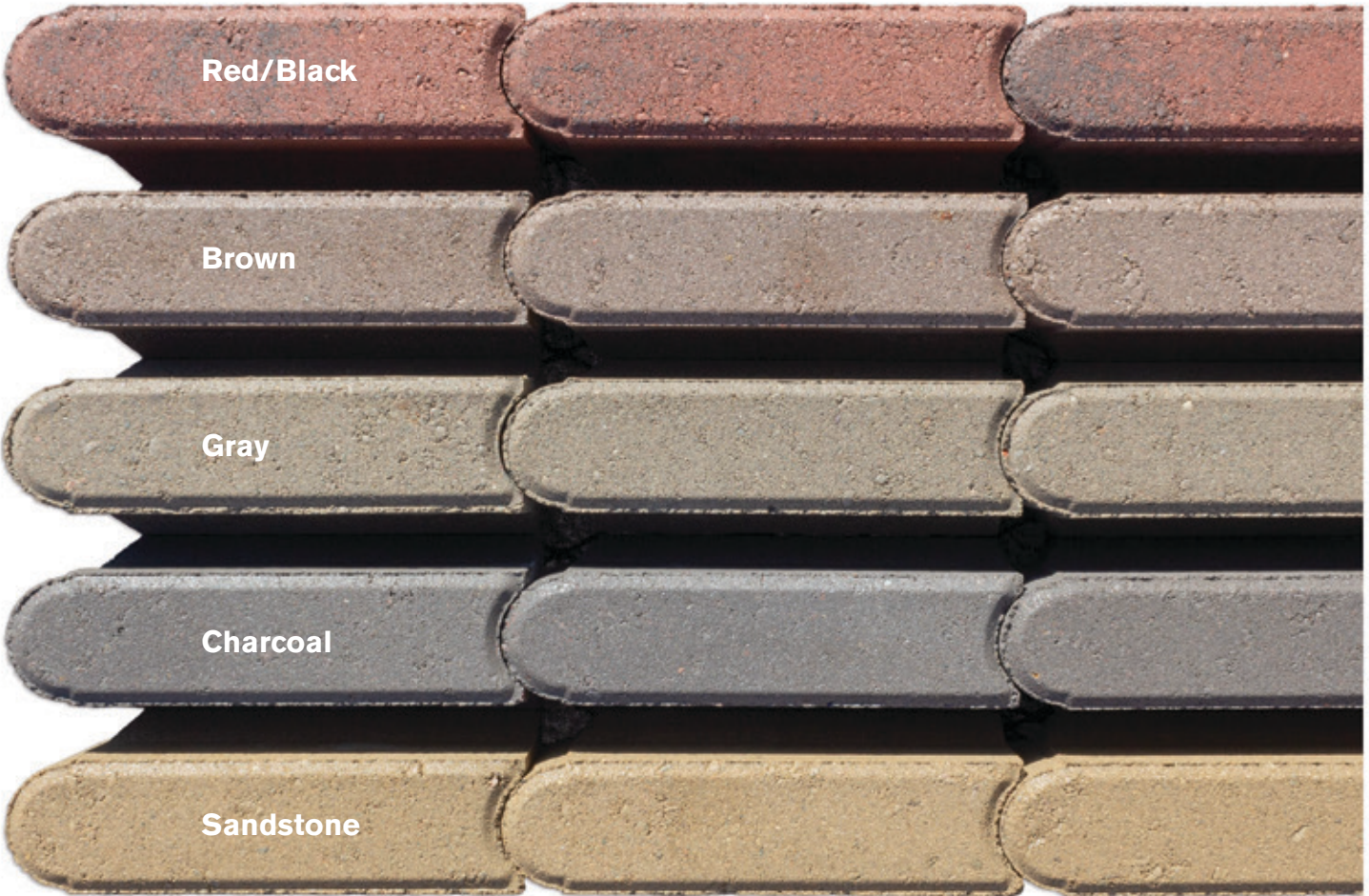

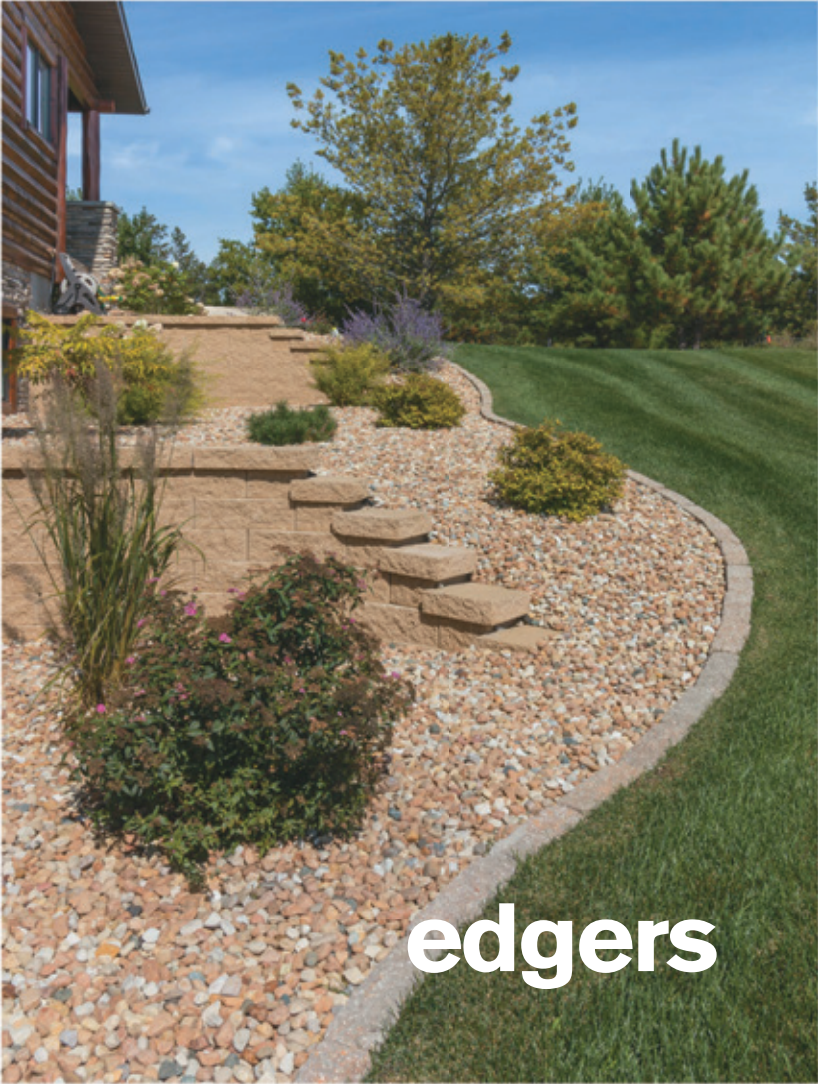

bullet edger

Layed end to end, yearly production of Interlock's bullet edger would stretch over 70 miles in length.

One size (larger than typical edges):
 - 12.25" W x 4" D x 4" H

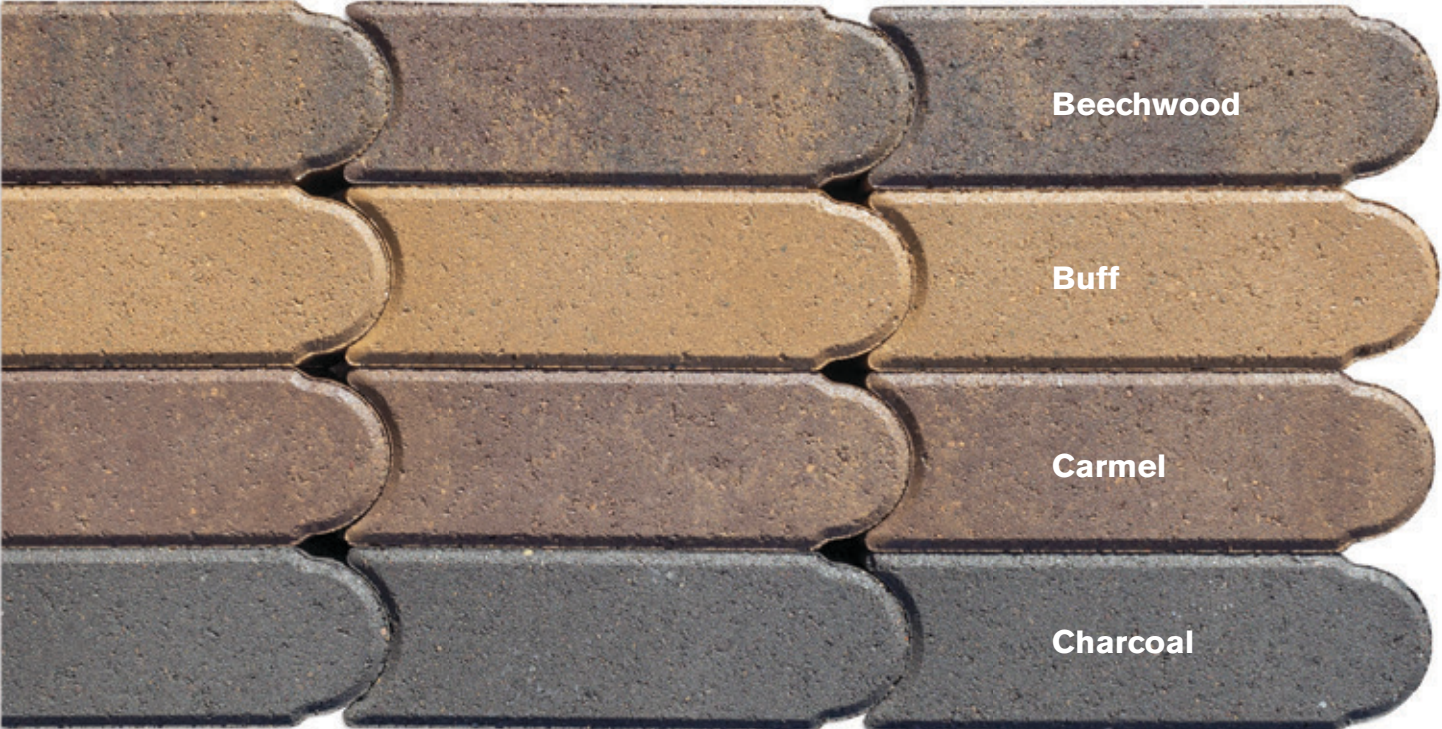



Affordable luxury

Necessaries kits are both beautiful and functional, turning backyards into attractive and enjoyable outdoor living spaces. Also, Necessaries come ready-to-assemble with everything needed to build, making them easier to install and more affordable than typical masonry structures.

Easy to build

Each Necessaries Outdoor Living Kit comes complete with everything you need to build, including pre-cut block sized to fit, reinforcements, adhesive, and easy-to-read, step-by-step instructions. Most kits can be built by two people in an afternoon, or less.

necessaries outdoor living kits

Necessaries is a collection of affordable, ready-to-assemble outdoor fireplaces, island bars and grills, kitchens, tables, waterfalls, fire rings, seat walls and pillars kits.

<p><small>No cutting, no guessing, no hassles – no problem®</small></p> <p><i>necessaries</i>™</p> <p>kits for outdoor living</p>	<p>ROCKWOOD RETAINING WALLS <i>A better way.™</i></p>
---	--

Expand anytime

You can build your project all at once or add new features over time. Because of Necessaries' modularity, expanding your outdoor living space is easy to do whenever you are ready.

Earthy colors

Necessaries kits feature Rockwood Retaining Walls' multi-piece, tumbled Lakeland and Riverland wall systems and are available in Beechwood, Bluestone, Desert, and Santa Fe colors. Necessaries mantels, tops and caps are cast from Indiana limestone originals and have smooth, honed surfaces with hand-chiseled edges.

Outdoor Living Kits are not suitable for commercial installations or applications.



Beechwood
brown/charcoal/buff



Bluestone
gray/brown/charcoal



Desert
sandstone/blush/brown



Santa Fe
gray/sandstone/brown

www.outdoorlivingkits.com

See Necessaries on HOMETIME.





grand fireplace kit

The **Grand Fireplace Kit** is the perfect centerpiece for your outdoor living room. Its appeal comes from its large profile, universal design and aged appearance. Includes Outdoor Lifestyles 36" stainless steel, wood-burning insert, log rack and spark curtain. Adaptable for natural or LP gas.

- 4' stainless stovepipe chimney
- Spark suppressor cap
- Optional Grand Wood Box Kit available left or right side
- Optional Grand Hearth Kit
- Optional Gas burner/log set*

*Not suitable for commercial installations

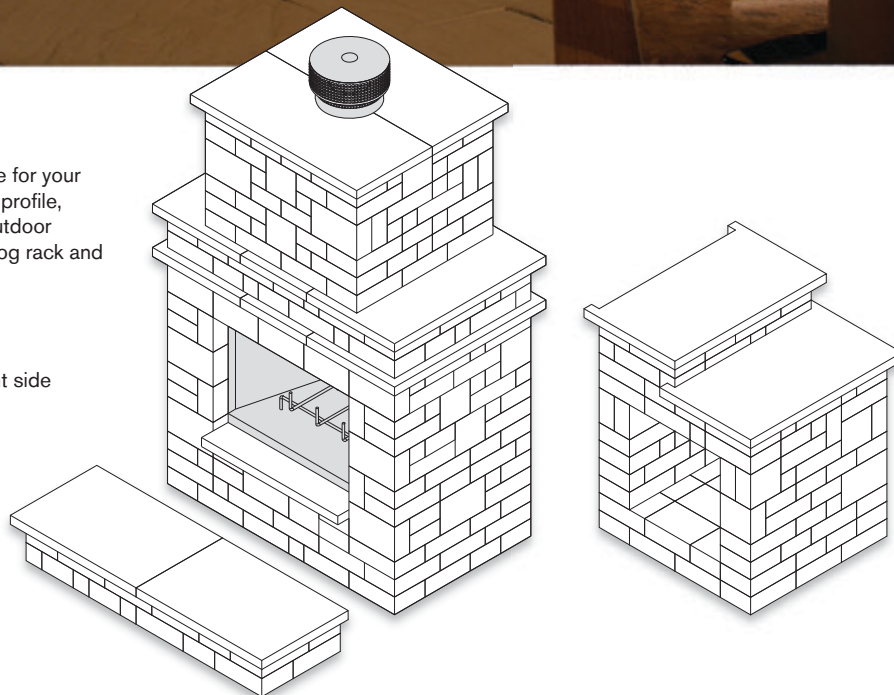



contemporary gas fireplace kit

The clean lines and simple profile of the **Contemporary Gas Fireplace Kit** create a backyard centerpiece perfect for homes with sophisticated style. The ventless, stainless steel insert features electronic ignition, glass wind screen and glass bead fire bed.

- Firegear stainless steel gas insert*
- 43,000 max BTU/hr
- Specify natural gas or LP fuel type
- Electronic ignition
- Stainless steel rear access door
- Optional Hearth Kit

*Not suitable for commercial installations

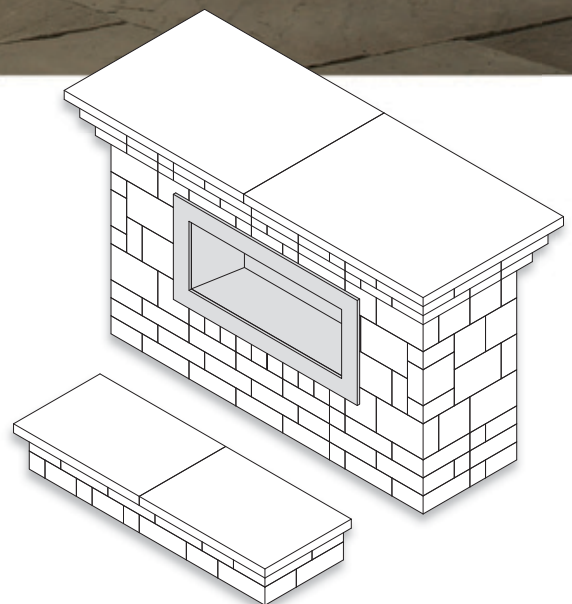

Before planning your landscape project, check with your local zoning commission for building restrictions and required construction permits. Always call 811 before you dig.



The **Compact and Colonial Fireplace Kits** are ideal for smaller backyards and patios. Each kit comes complete with 2.25" thick firebrick, ensuring durability and enhancing the overall appearance.

Popular for their affordability and smaller footprints, these fireplaces will generate warm accolades from family and guests for years to come.

- 2.25" fire brick
- Optional Wood Box Kit available left or right side
- Optional Hearth Kit
- Optional Gas burner/log set*

gas option available

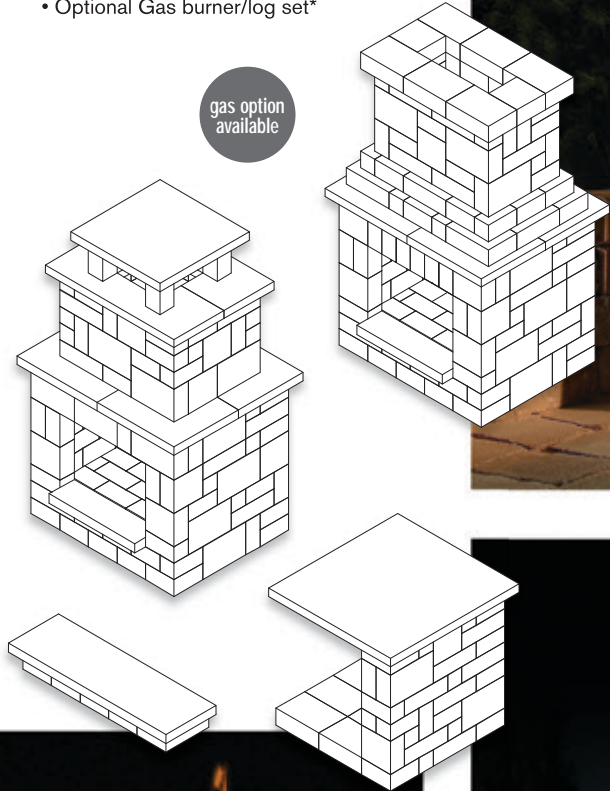

colonial fireplace kit



compact fireplace kit

Gas Burning Option*

- 18" iron log rack
- 2 burner, 52,000/49,000 max BTU's
- Specify natural gas or LP fuel type
- Arizona Weathered Oak ceramic log set

*Not suitable for commercial installations



victorian fireplace kit

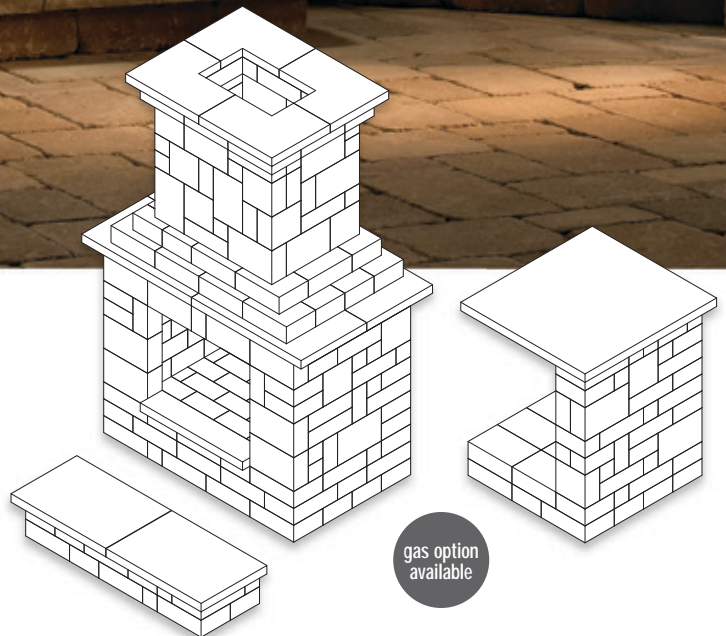

Larger and taller than the Compact Fireplace, the **Victorian Fireplace Kit** becomes the focal point in any backyard. Comes complete with 2.25" thick firebrick, ensuring durability and enhancing the overall appearance.

- 2.25" protective fire brick
- Optional Wood Box Kit available left or right side
- Optional Hearth Kit
- Optional Gas burner/log set*

*Not suitable for commercial installations

Grand Fire Ring Kit

- 48" D x 12" H (31" interior dia.)
- One-piece, heavy gauge, solid steel insert protects block
- Optional Fire Ring Block Layer – add layers to increase height
- Optional Fire Ring Cap – chiseled edge, eight-piece, in three colors, 2.25" H
- Optional Swivel Cooking Grate – removable, heavy steel construction, ADA compliant
- Optional E-Z Access Spark Screen – keep ash and sparks inside and debris out, hinged for easy access
- Optional Cover – heavy galvanized steel with or without cooking grate slot



Optional fire ring cap



grand fire ring kit



Optional swivel cooking grate



victorian fire pit kit

necessaries

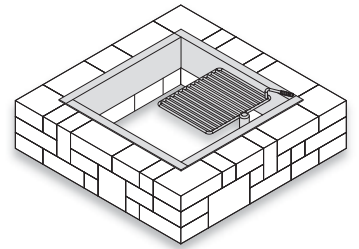

No matter the locale, there will be cool evenings to enjoy the warmth of a backyard fire. A Necessaries Fire Ring adds charm to any backyard design. Because they're built with high-quality Rockwood block and a U.S. Park Service grade steel insert, they will last indefinitely.

Victorian Fire Pit Kit

- Four-piece, heavy gauge, solid steel insert protects block
- Optional Swivel Cooking Grate

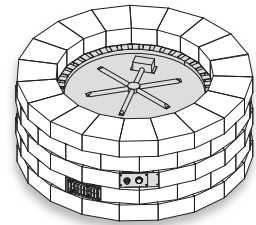

Designed for slab, paver or gravel bases, the Grand Gas Fire Ring Kit has both style and convenience. Smokeless and ashless, it's an ideal alternative for properties with open burning restrictions.

Grand Gas Fire Ring Kit*

- Push-button electronic ignition
- 65,000 max BTU/hr
- Specify natural gas or LP fuel type
- Thermo-couple auto shut-off feature
- #304 stainless steel construction
- 50 lbs. lava rock
- Optional Fire Ring Cap (chiseled edge, eight-piece, in three colors, 2.25" H)
- Optional Arizona Weathered Oak Log Set
- Optional nylon fabric cover

*Not suitable for commercial installations



grand gas fire ring kit



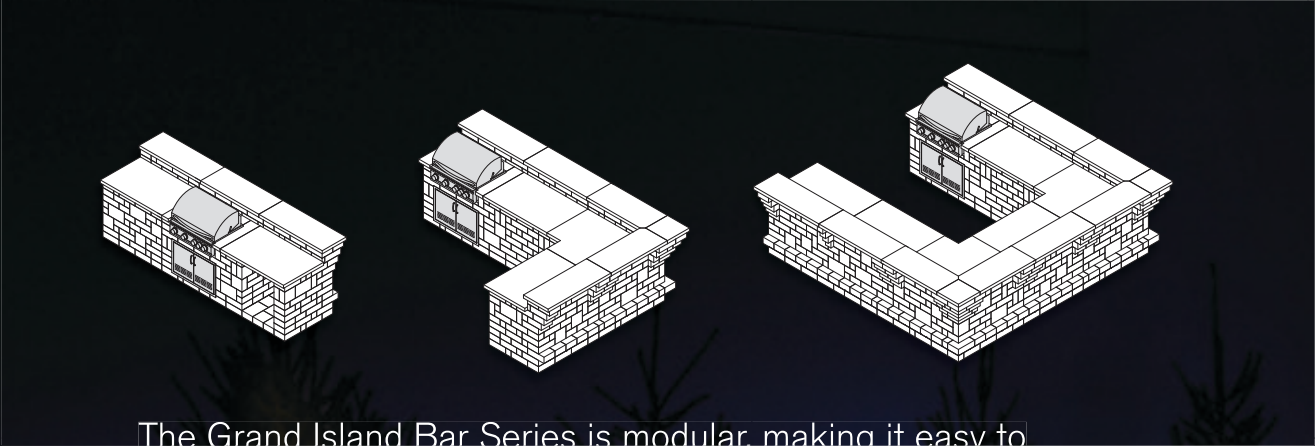

The Grand Island Bar Series is modular, making it easy to design and build large kitchen and entertainment areas.



Includes Summerset
Sizzler 32" NG or LP grill



 **Summerset**[®]
PROFESSIONAL GRILLS

necessaries

grand island bar series



Single door with grill as shown no longer available.
Kits not suitable for commercial installations.

necessaries

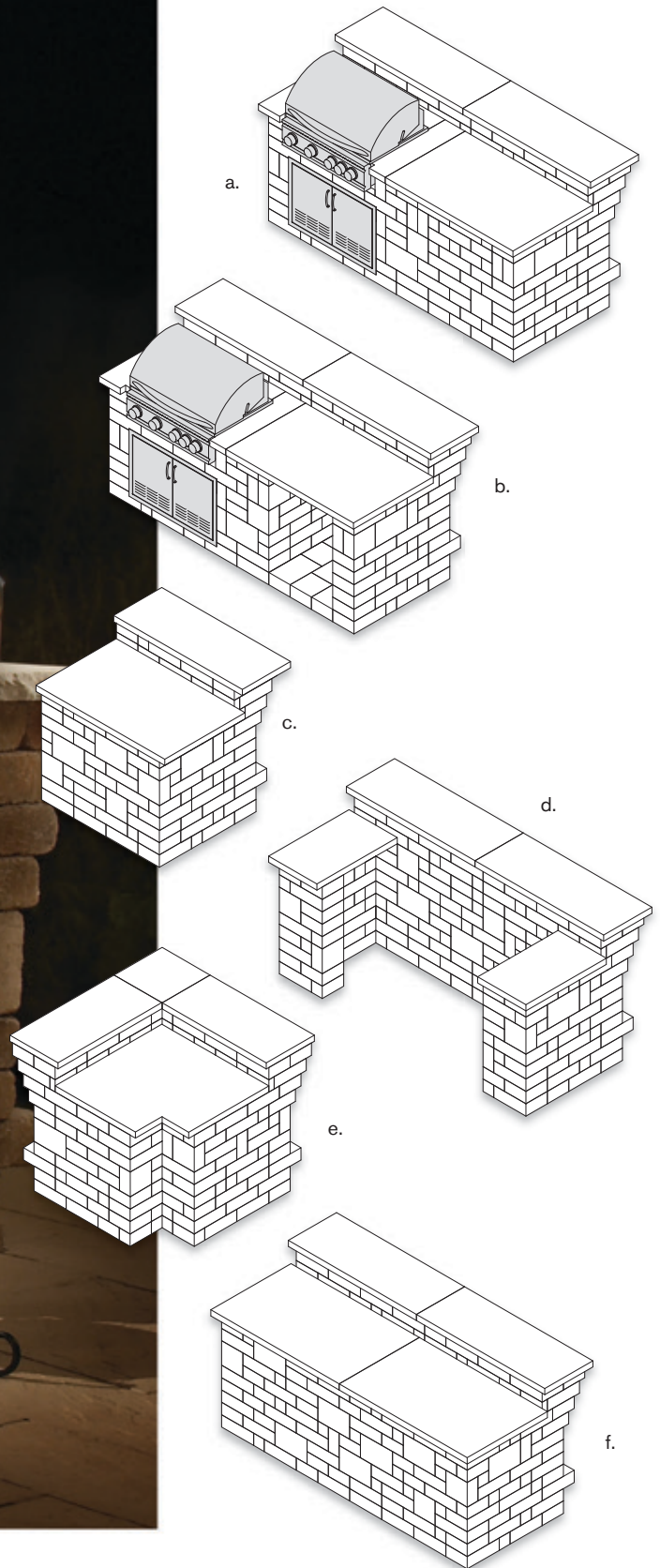

For outdoor living enthusiasts who love cooking and entertaining, the **Grand Island Bar/Grill Series** is a wonderful addition to your home's backyard.

- a) Grand Island Bar/Grill with Storage Kit**
- Summerset Sizzler 32" grill*
 - Stainless steel double doors

- b) Grand Island Bar/Grill with Refrigerator Opening Kit**
- Summerset Sizzler 32" grill*
 - Stainless steel double doors

- c) Bar Section 4' Kit**
- Adds 4' to Grand Island Bars
 - Left or right facing

- d) Grill Surround Kit**
- For standing grills, 60" opening

- e) Corner Return Kit**
- Makes L-shaped bar/grill

- f) Grand Island Bar 8' Kit**

wood-fired outdoor oven



This beautiful stand-alone **Wood-fired Outdoor Oven*** is sure to be enjoyed for its ease of use and ability to bake delicious entrées, desserts and pizzas in minutes.

- 24" x 24" cooking surface
- Handcrafted in Sicily
- #304 stainless steel construction
- Color: Hammered Copper
- Optional Wood Box/Stand Kit
- Optional nylon fabric cover

*Exact style, color and features may vary.

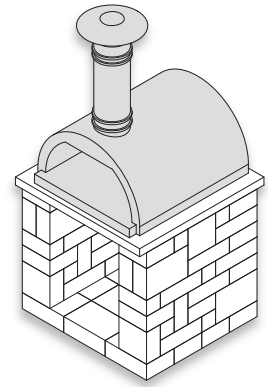

Compact Bar Kit

- Builds open or closed front

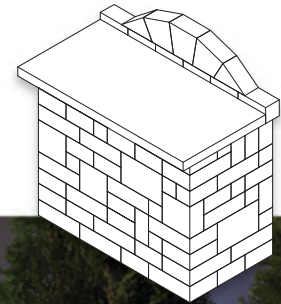
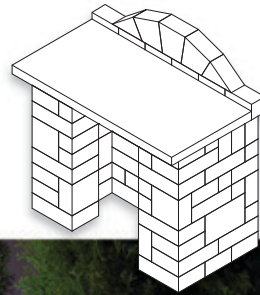

compact bar kit





dining table kit

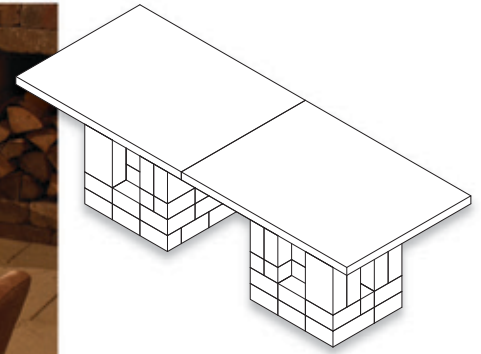

Every outdoor dining and living room should include functional and attractive furniture.

The Necessaries **Dining Table** is easy to maintain, will never blow away in a storm and will outlast all others. The Necessaries table fits easily into any outdoor dining room design.

Dining Table Kit

- 36" W x 96" D (top)
- 30" tall, dining chair height
- Seats eight easily



pub/bistro table kit

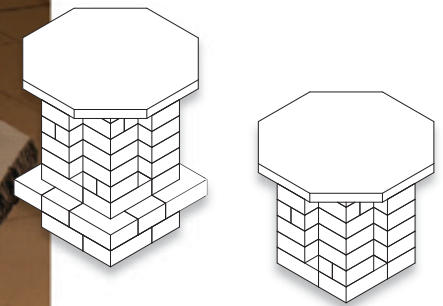

No patio is complete without a place for guests to enjoy tasty hors d'oeuvres, cool drinks, and conversation.

These stylish **Pub and Bistro Tables** are the perfect size for enjoying a cold drink and summertime snacks. The hand-chiseled 36" octagon top adds a distinctive look to any outdoor area.

Bistro Table Kit

- 30" height

Pub Table Kit

- 42" height
- 4" foot rail

Waterfall kits are easy to build and essentially maintenance-free. These above-ground designs are ideal when in-ground ponds and waterfalls are not suitable. Waterfall kits include all plumbing/connections. Catch basin stones not included.

Grand Waterfall Kit

- 1,350 gph mag drive pump
- 48" half-round basin
- 23" stainless steel spillway
- Optional LED light kit

Compact Waterfall Kit

- 850 gph mag drive pump
- 26" square basin
- 11" stainless steel spillway
- Optional LED light kit





Pillars can be added to **Seat Walls** or built as a freestanding landscape feature, such as a property marker or light base.

a. 20" Pillar Kit

- 2.25" H chiseled cap

b. 20" Pillar with Glass Kit (lights not included)

- Pittsburgh Corning Premiere 8" glass block
- 2.25" H chiseled cap

c. 24" Pillar Kit

- 2.25" H chiseled cap

d. Lakeland Seat Wall Kit

- Creates a 6' straight wall
- Optional chiseled cap

e. Riverland Seat Wall Kit

- Creates an 8' radius wall
- Optional chiseled cap

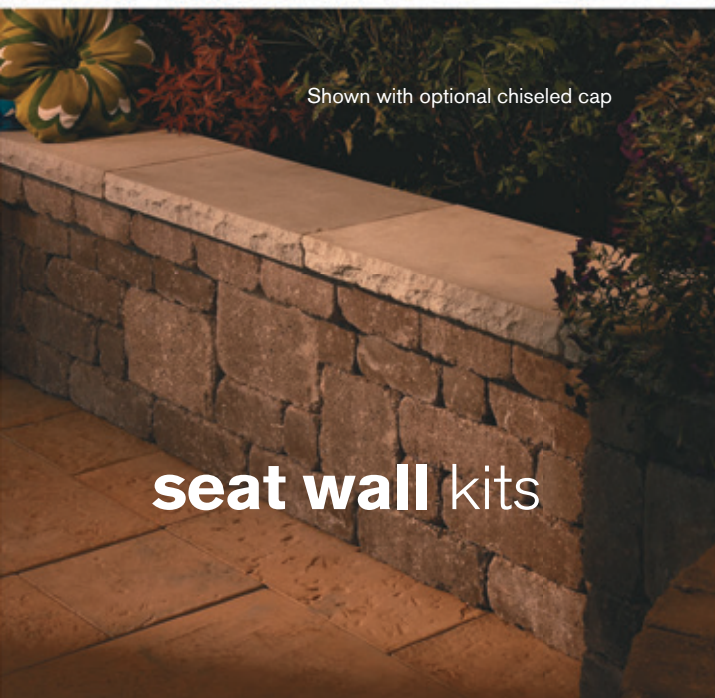
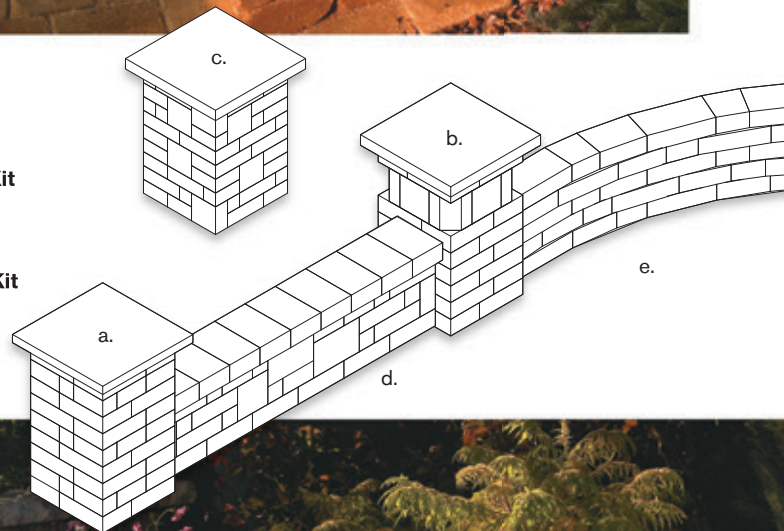

All dimensions shown in inches.

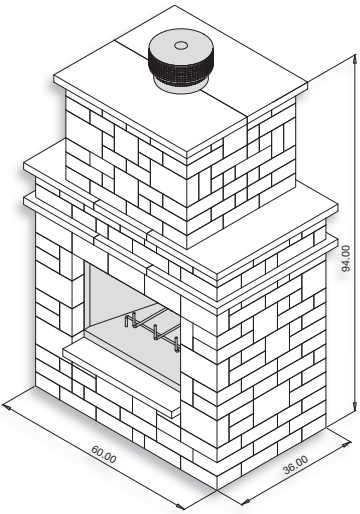

Grand Fireplace

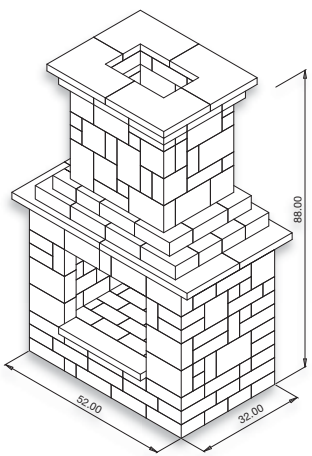
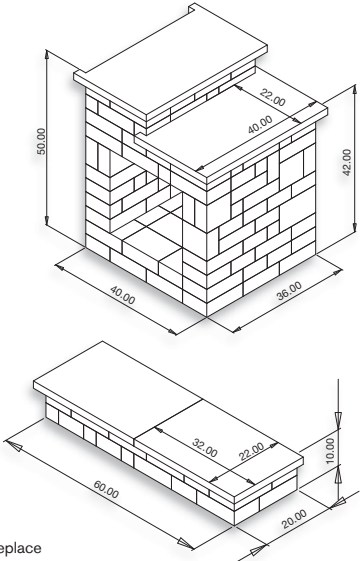

Victorian Fireplace

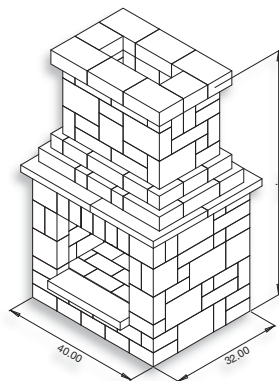
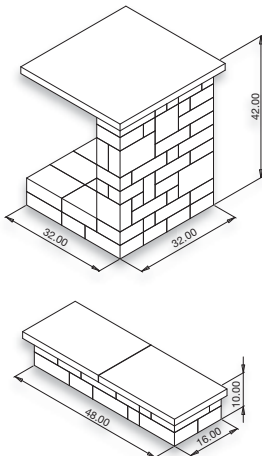

Colonial Fireplace

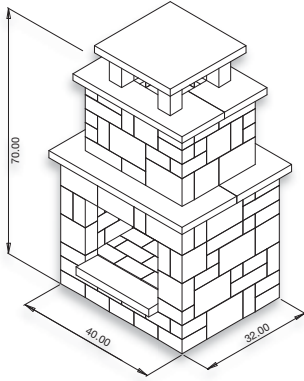
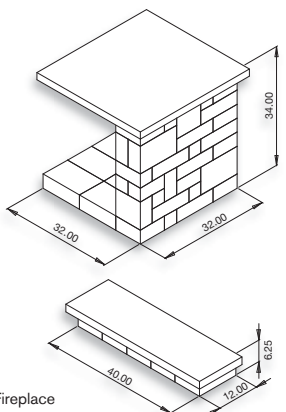

Compact Fireplace

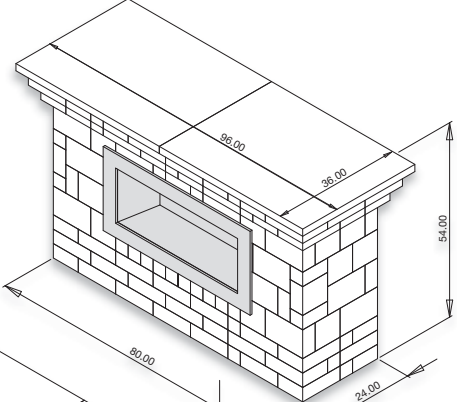
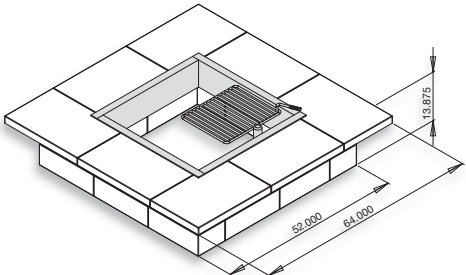
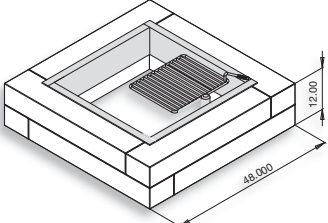
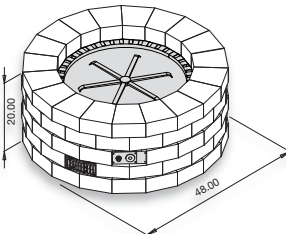
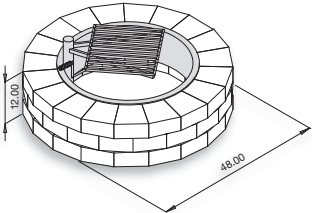
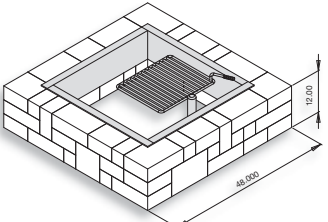
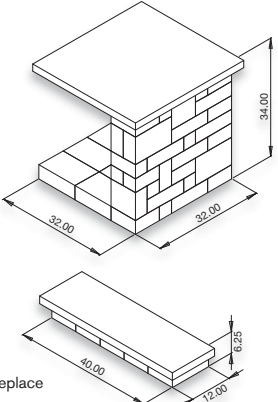

Contemporary Fireplace

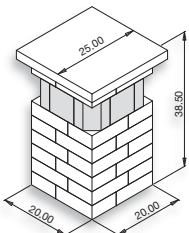
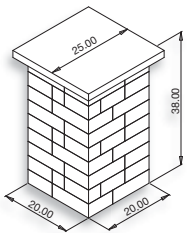
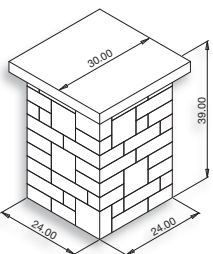

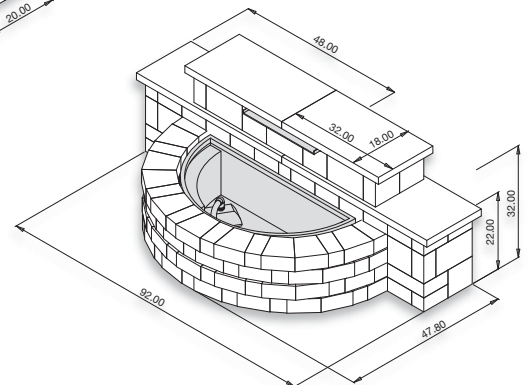
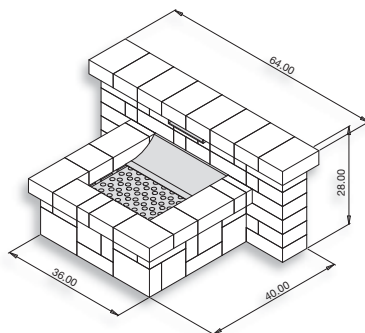
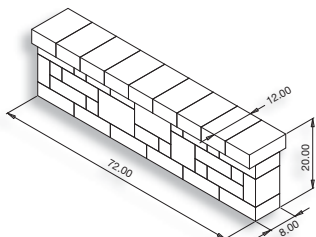
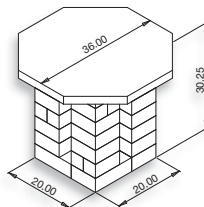
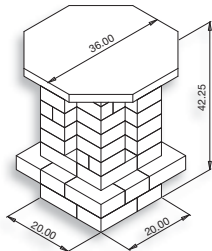
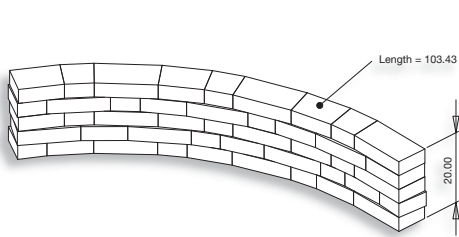
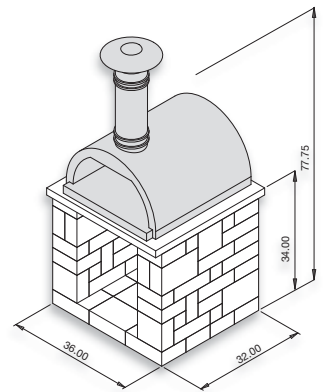
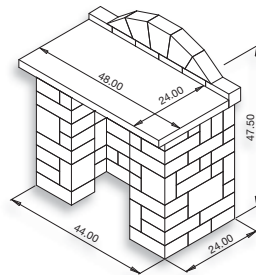
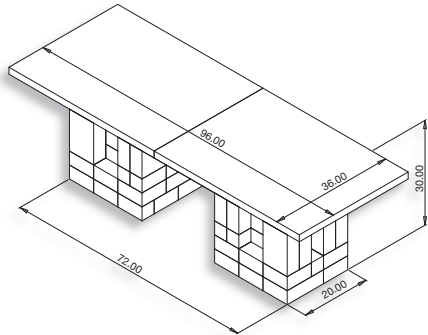
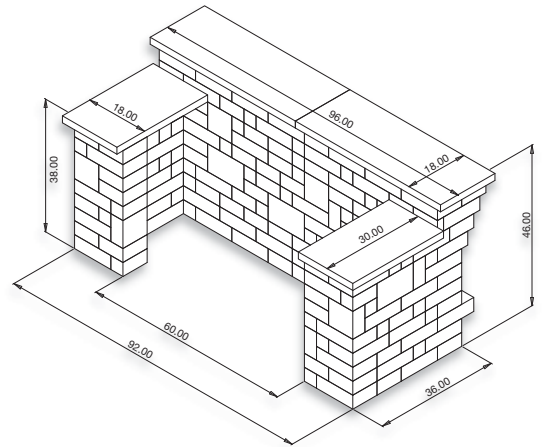
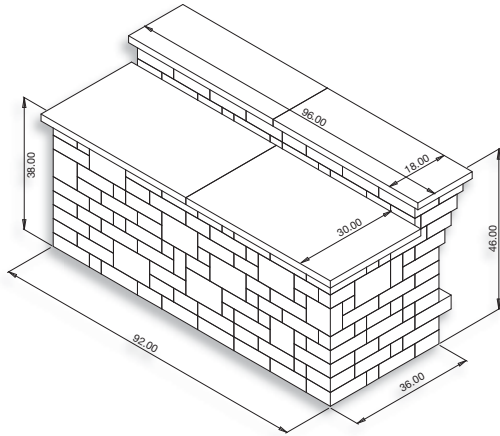
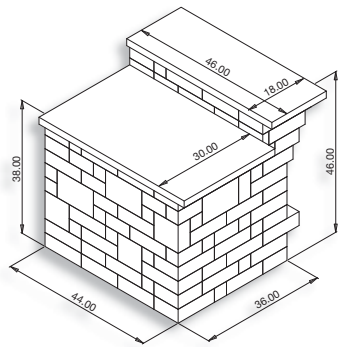
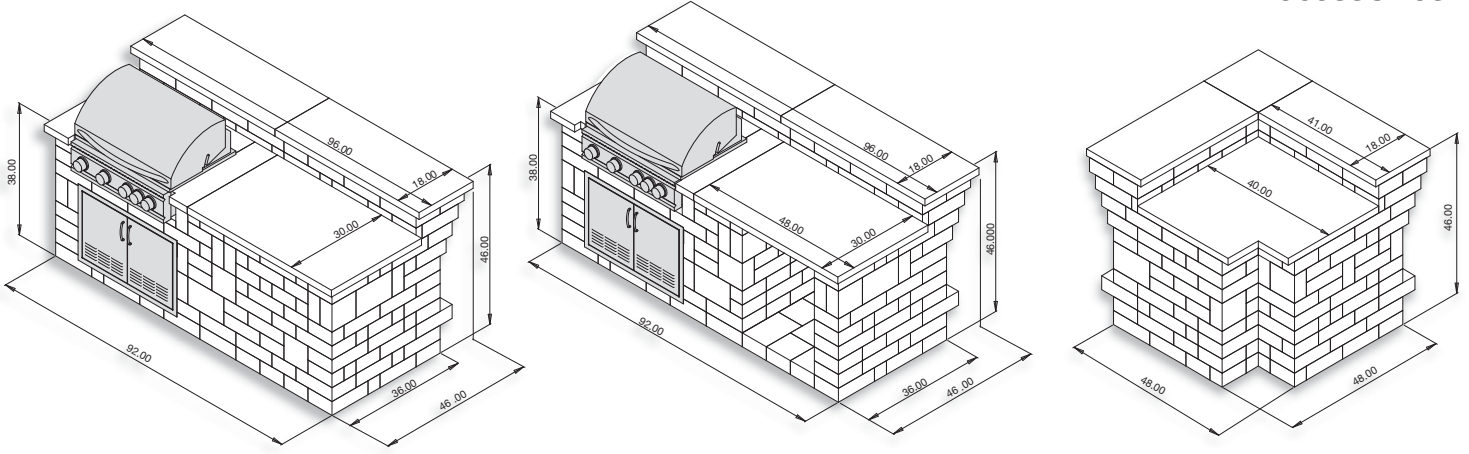



necessaries kitchen kits

are a collection of granite-topped cabinets for backyard baking, grilling, dining and entertaining. Elegant, functional and affordable, these quality components and cabinets are ready to assemble in any configuration you can imagine.

Kitchen cabinet kits with solid granite tops

Granite is an igneous rock formed billions of years ago when magma cooled deep beneath the earth's crust. Nearly as durable as diamond, granite owes its density and hardness to its origins – solidified under extreme pressure deep within the earth. Granite is as durable as it is beautiful; it's not affected by extremes in temperature and under normal conditions, resists etching by knives, household acids and kitchenware.

Besides its beauty, granite is...

- Sanitary – when sealed, granite does not harbor bacteria
- Highly resistant to burning or charring from hot pans, appliances, utensils etc.
- 100% natural and non-toxic
- Easily cleaned

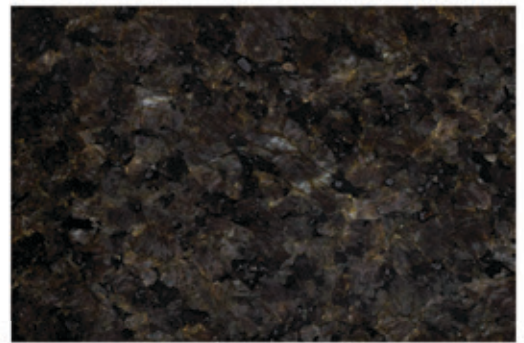

Black Pearl granite



Viscon White granite





Premium grills, ovens and kitchen components

The Kitchen features Summerset Professional Grills and stainless steel components. Their commitment to quality is reflected in the craftsmanship of their products that are backed by the strongest warranty in the industry.

Made with crazy-good stainless steel

The Kitchen grills and cabinet components are subject to constant use, and the damaging effects of time and Mother Nature. For these reasons, Kitchen grills and components use high-grade stainless steel for reliability and durability. These professional series grills are designed and built with performance, ease of use and total customer satisfaction in mind. With proper care and maintenance, they can last indefinitely.

The real strength comes from #443 stainless steel. Grade #443 stainless steel is an alloy high in titanium and chromium (making it magnetic), yet very low in carbon. High quality stainless steel was formally perceived as non-magnetic, but since the origin of #443 that is no longer true. Compared to other grades of stainless steel, #443 expands less when heated - meaning less stress, warping and corrosion - making it the choice for use throughout the Summerset Professional Grill Series.

Grade #304 is one of the most widely used grades of stainless steel. Its durability and beauty make it the preferred grade in the market. #304 is a non-magnetic alloy high in chromium and nickel with some carbon. It is used in the drawers, doors and sinks, along with the cooking grids and racks, because it will last like no other.

There are stainless steels you won't find in any of our products

Grades #201 and #202 stainless steel are comprised of nickel with magnesium or nitrogen. These alloys were created to reduce costs; they are not magnetic, nor stand up to the elements as well as grades #304 or #443. Commonly used in grills and appliances of lesser quality, #201 and #202 are more likely to experience corrosion when subject to high temperatures.

Backed by some serious warranties

Grills: Limited lifetime warranty on construction and manufacturer defects. Limited lifetime warranty on frame and housing. Limited lifetime warranty on cooking grates, burners and valves. One year warranty on all other parts, components, and electrical.

Components: Limited lifetime warranty on construction, workmanship and materials for all stainless steel components, including doors, drawers, ice chests, beverage centers, sinks and grill liners.

Granite/Concrete: All Kitchen cabinets come with a limited lifetime warranty on the granite and concrete against material defect.

Note: Summerset warranty does not cover commercial or rental applications. It does not cover discoloration, surface rust, corrosion, or oxidation, which may occur due to harsh environments, chemicals or overheating. Warranty does not cover damage resulting from improper installation, abuse, alterations, misuse, or improper care. All warranties are subject to manufacturer review. Warranty covers replacement parts only. It does not cover labor or labor related charges. Registration form for appliances must be submitted within 30 days of purchase date to validate the above warranty. For complete warranties, visit us online at www.outdoorlivingkits.com



- 15,000 Btu/hr infrared back burner
- 8mm cooking grates won't warp or rust
- Easy-clean briquette system for even heat



- Easy-glide stainless steel drawers and magnetic-close doors
- Polished handles

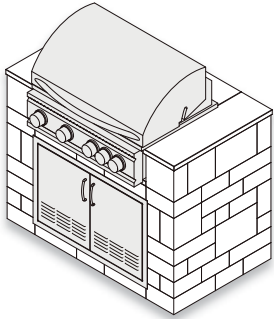

32" Sizzler Grill Cabinet*

- 48" W x 28" D x 37" H
- 4 main burners
- 795 sq. in. cooking surface
- Pro Sizzler option

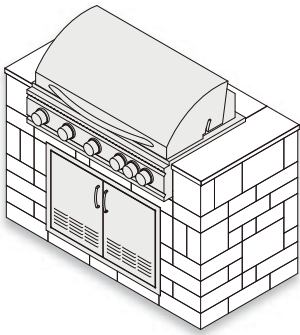

40" Sizzler Grill Cabinet*

- 56" W x 28" D x 37" H
- 5 main burners
- 985 sq. in. cooking surface
- Pro Sizzler option

Summerset Sizzler Grills (standard)

- #443 stainless steel construction
- Push-to-turn knob ignition
- 3" temp gauge
- 12,000 BTU #304 stainless steel burners
- 15,000 BTU infrared back burner
- Natural gas or propane fuel
- Double-lined hood for optimal airflow
- 8mm cooking grates won't warp or rust
- Easy-clean briquette sys. for even heat
- 30" double stainless doors
- Choice of granite/cabinet colors

Pro Sizzler Grills (upgrade)*

- + Exterior LED lights
- + 14,000 BTU cast burners
- + Heat zone separators
- + Interior cooking lights
- * Requires 120 volt electrical

Deluxe Rotisserie (optional)

- #304 stainless steel
- Heavy-duty motor, 25 lb. capacity

*Not suitable for commercial installations.



sizzler grill kits

The Pro Sizzler features will be appreciated with every use!



necessaries - the kitchen



wood-fired oven kit

This beautiful stand-alone wood-fired outdoor oven is sure to be enjoyed for its ease of use and ability to bake delicious entrees, breads, desserts and pizzas in minutes.

Wood-fired Pizza Oven

- 32" W x 30" D x 40" H
- 24" x 24" cooking surface
- Handcrafted in Sicily
- #304 stainless steel construction
- Reinforced, stainless steel chimney pipe
- Stainless steel wood caddy
- Stainless steel door
- Thermometer
- Color: Hammered copper

Woodbox/Stand Kit

- 4.75 cu. ft. of storage
(16" W x 16" D x 32" H opening)
- Choice of granite/cabinet colors

* See page 102 for current style



Oven Toolkit Set

These Italian made cooking tools for wood-fired ovens will be appreciated for their ease of use and lasting quality. Each handle features a loop for hanging.

- Large rounded peel has a 11.5 x 12" head and a 45" reach
- Small, 7" dia. peel has stainless handle, stay-cool plastic grip with unique sliding handle feature
- 6.5 x 2" W oven brush has brass bristles, aluminum handle with a 43" reach

See page 68 for current oven style.



Scan this QR code to learn about wood-fired cooking, oven use and care.



the **kitchen**
by necessities



island kit



The **Island Cabinet Kit** is the centerpiece of your outdoor kitchen. Large enough to seat six adults, with over 28 sq. ft. of surface for prep, dining and entertaining.

- Two easy-glide stainless steel drawers and magnetic-close door
- Choice of granite and cabinet color

Drop in Sink (optional)

- 15" L x 15" W x 6" D basin stainless sink
- Double handle valve stainless faucet
- Stopper/strainer

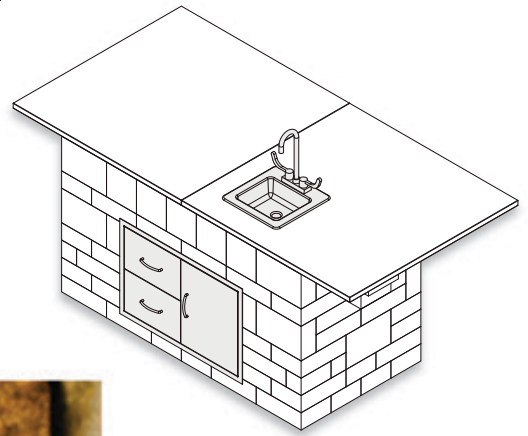

refrigerator kit

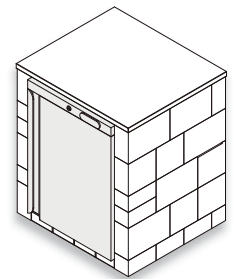

Refrigerator Cabinet Kit

- 24" W x 24" D x 36" H opening
- Choice of granite and cabinet color

Refrigerator (optional)

- UL Certified for outdoor use
- #304 stainless steel construction
- 5.5 cu. ft. capacity
- Reversible door with lock and key
- Digital temperature display

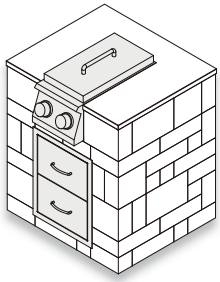

Side Burner Cabinet Kit

Combine the comfort of an indoor kitchen range with all the benefits of being outside. Specially designed for performance and function, Summerset's double side burner is the perfect addition to your outdoor kitchen.

- #304 stainless steel construction
- Push-to-turn knob ignition
- Two easy-glide stainless steel drawers
- 24,000 Btu/hr solid brass burners
- 19.5" x 10.5" cooking surface
- Choice of granite and cabinet color

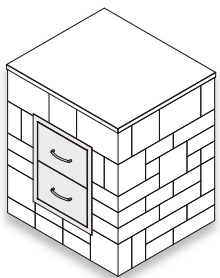

Two Drawer Cabinet Kit

- Easy-glide stainless steel drawers
- Fully enclosed stainless steel outside
- Choice of granite and cabinet color



side burner kit

www.outdoorlivingkits.com





smoker kit

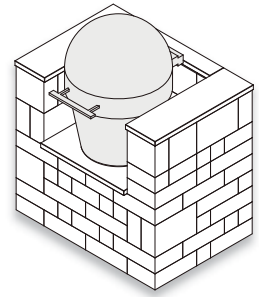

Smoker Cabinet Kit

- 24" W x 24" D opening for your smoker
- Choice of granite and cabinet color
- Smoker not included or available

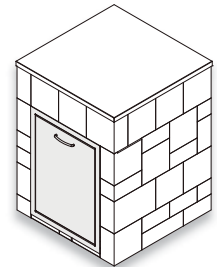

Trash Drawer Cabinet Kit

- #304 stainless steel construction
- Easy-glide pullout drawer
- Accommodates a 12-gallon trash can
- Choice of granite and cabinet color

Summerset's trash drawer is completely enclosed to protect against animals and insects.



Kitchen Kits - Standard Features

- Easy-to-read, step-by-step instructions
- Rockwood's multipiece Lakeland/Riverland block
- Solid granite tops in two color choices
- Reinforcements and concrete precut and sized to fit
- VOC-compliant adhesive and gloves

corner kit



prep center kit

With over 9 sq. ft. of surface, the Prep Center Cabinet will be appreciated for its generous workspace. Build it with the optional sink and your outdoor kitchen is truly complete.

- Two easy-glide stainless steel drawers and magnetic-close door
- Choice of granite and cabinet color
- Optional 15" stainless sink and faucet

- Drop in Sink (optional)
- 15" L x 15" W x 6" D basin stainless sink
 - Double handle valve stainless faucet
 - Stopper/strainer

necessaries - the kitchen

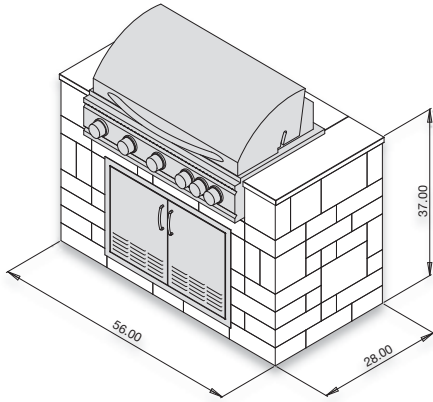

40" Grill Cabinet

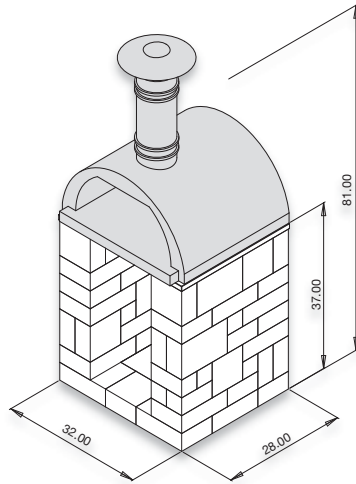

Wood-Fired Outdoor Oven Woodbox/Stand Cabinet

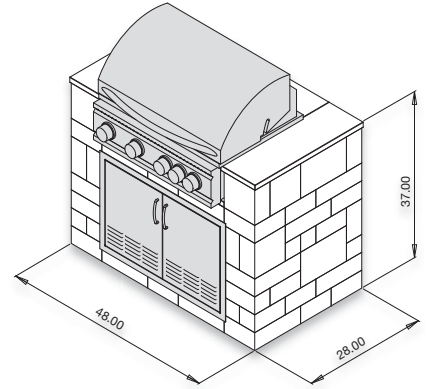

32" Grill Cabinet

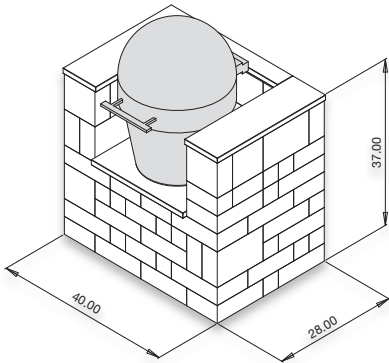

Smoker Cabinet
(Smoker not included)

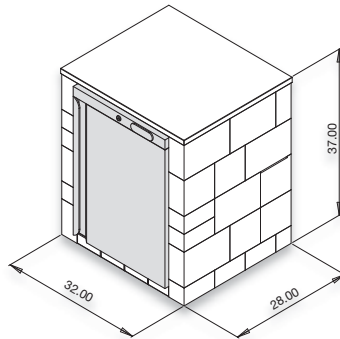

Refrigerator Cabinet
(Optional refrigerator)

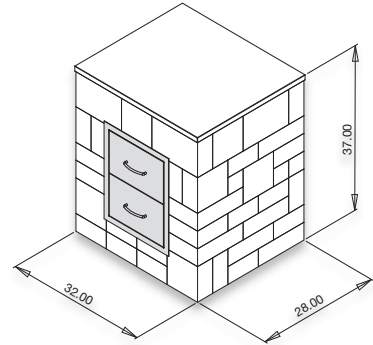

Two Drawer Cabinet

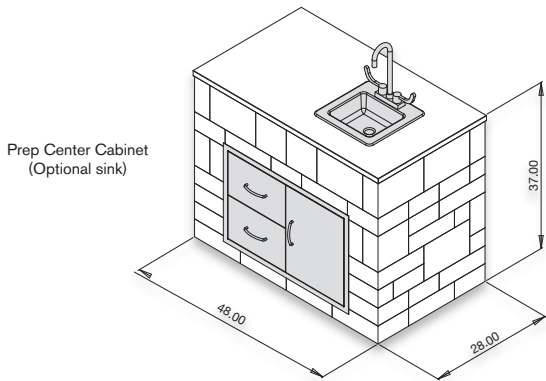

Prep Center Cabinet
(Optional sink)

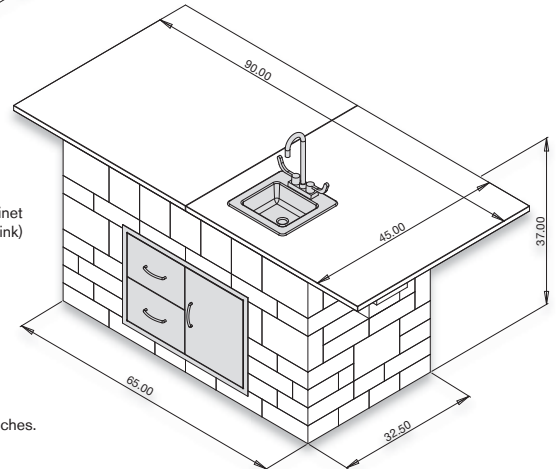

Island Cabinet
(Optional sink)

All dimensions shown in inches.

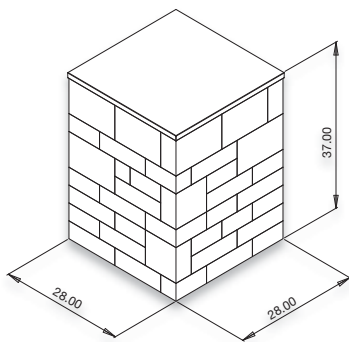

Corner Cabinet

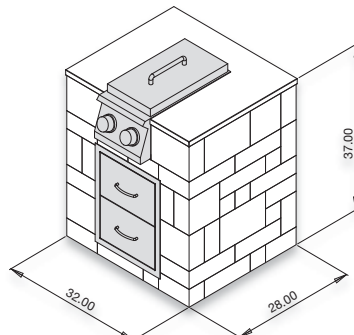

Side Burner Cabinet

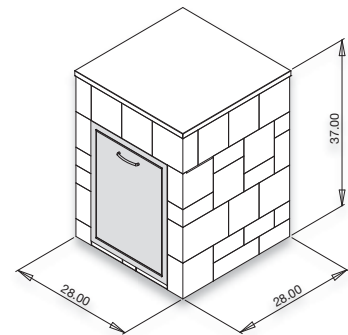

Trash Drawer Cabinet

welcome to the backyard...



Corporate Office:
7200 North Broadway
Rochester, MN 55906
(507) 288-8850
(507) 288-3810 (fax)

W6558 Hwy 33
Juneau, WI 53039
(920) 386-3333

N14665 Dickerson Ave.
Thorp, WI 54771
(715) 669-5552

3535 Bluff Drive
Jordan, MN 55352
(952) 492-3636

www.rochestercp.com

© Copyright 2019, Rochester Concrete Products. All Rights Reserved. All trademarks and registered trademarks are the property of their respective owners. Rockwood Retaining Walls products are made worldwide under license from Rockwood Retaining Walls, Inc. US and international patents issued and pending. The information presented here has been prepared for the benefit of customers interested in Rochester Concrete Products, it was reviewed carefully prior to publication. Rochester Concrete Products assumes no liability for its accuracy or completeness. Final determination of the suitability of any information or material for the use contemplated, or for its manner of use, is the sole responsibility of the user. 119



The 2019 Hardscapes Color Selector and Specifications Guide is available online.

